

 **ICS** **Food Machinery**
KARAFYLLIS INFORMATION SYSTEMS



PRODUCT LIST
2026

Since 1987

Company profile



ICS Head Office: Athens



ICS Branch: Thessaloniki

ICS Karafyllis S.A. is a modern company that is constantly evolving in line with technological developments and the demands of modern commerce, implementing a quality management system.



It holds a leading position in providing integrated solutions for the organization and operation of many businesses in sectors such as logistics, supply chain, tourism, health, Retail, Industry, Distribution - Transportation, Public Administration, and Food Chains.

The company's strength lies in its expertise, its wide range of products and solutions from the largest foreign companies, and its large network of partners.



It operates with three commercial divisions:

- IT – Tax Solutions.
- Professional Catering Equipment.
- Anti-theft Systems/Digital Signage/New Technologies.

In the field of Specialized Professional Equipment, it provides modern and reliable machinery for the Catering, Retail, and Food Processing sectors, with a wide variety of Scales, Multi-cutters, sausage machines, multi-purpose machines, pastry mixers, meat grinders, baking appliances, vacuum sealers, packaging machines, heat sealers, refrigerators, and display cases. We represent many European cutting and packaging machine manufacturers such as **SWEDLING-HAUS, PSV, MINERVA, WAAGE, OPEN, EASY TURN, CELME, FAMA, SIRMAN, KT, CELSA, CGT, FIAMMA, ALLFO, OMS, AK, GHIZZONI, MISTRO, MISKA, MUNKFORS, TRE SPADE**, as well as some quality Chinese products from Dynamic for more economical solutions. A wide variety of weighing solutions from many European companies such as **T-SCALE, AVERY BERKEL, MARQUES, NAGATA, KINGSHIP**. It offers complete solutions for supermarkets, professional kitchens in restaurants, bars, cafés, hotels, catering, ships, cruise ships, campsites, butchers, Fishmongers, Fruit Markets, Open-air Markets, Bakeries, Patisseries, Mini Markets, Delicatessens, Ice Cream Shops, Waffle Shops, Creperies, Pizzerias, Fast Food Restaurants, Burger Houses, Souvlaki Shops, Entertainment Venues, Events and recreation, conferences and professional events, cooperatives, food processing units, food production workshops and laboratories.

In the field of Specialized Professional Equipment, it provides modern and reliable . It also offers equipment with IT systems such as cash registers, POS, scanners, price checkers, barcode printers, portable terminals, waiter call systems, customer priority systems, electronic labels, coin counters, counterfeit detectors, automatic cash drawers, and more.

It supports its customers and partners in remaining competitive and has dedicated service, repair, and support departments with specialized technical staff for all the solutions it promotes.

Alphabetical *(contents)*

B	Back Bar Cooler Inox	196-199	G	Glass and container rinsing appliance	166-167
	Bag sealer	243		Glass polisher	165
	Bain Marie	87		Grill	82
	Beef machine gelatine	63	H	Hanging scales	274
	Beer refrigerator	187		Heated display cases	174-180
	Box sealing appliance	240		Heated nachos display case	114
	Brine pump	59		Hot dog grills	116
	Burger machine	95		Hot dog warmers	115-116
	Burger machine paper	64	I	Ice cream cone maker	96
	Burger moulds	60-61		Induction hobs	120-122
C	Cheese graters	30-33	J	Juice cooler	132
	Cheese sauce dispenser	114		Juicers	129-130
	Chocolate dispenser	96	K	Knife sanitizers	68
	Coffee maker	136, 138		Knife sharpener	73
	Convection ovens	109-112	L	Label holders	254-255
	Cooking appliances	156-158		Label makers	280-282
	Cutter	139-142		Label scales	260-262
D	Deep fryers	84-86		Labels	283-285
	Dishwasher / Cutlery polisher	164		Ladder racks	248
	Display trays	249-250	M	Meat grinder screens	49
	Double chamber vacuum	231-232		Meat mixer	56-58
	Double refrigerator	188		Meat tenderizer	67
	Dough moulds	118		Microwave ovens	107-108
E	Egg cooker	89	N	Neutral display cases	184-185
	Electronic scales	265-267	P	Pallet truck scales - Mechanical	273
F	Fast proofers	150-153		Pasta cooker	88
	Film appliances	242-244		Piece counting scales	276
	Fish scalers	163		Pizza ovens	119
	Food dehydrators	113		Priority system	256-257
	Frappé machines	134			
	Freon scales	266			
	Frozen food refrigerator	190			

R	Refrigerated display cases	193
	Refrigerated sushi display case	194-195
	Rice cooker	93
	Rotisserie knives	161-162
S	Salad bar display case	200-203
	Salad spinner	163
	Salamander	90
	Sausage machines	8-26
	Sausage machines knives	27
	Sausage stuffer	50-55
	Scales with price calculation	262-264
	Slicers	65-66
	Soft drink display case	191-192
	Soft drink refrigerator	186
	Soup tureen	93
	Storage refrigerator	189
T	Toasters	76-79
	Toasters	91-92
V	Vacuum bags	234-239
	Vacuum floor models	229-230,233
	Vacuum scales	210-217
	Vacuum skin packaging models	218
	Vacuum tabletop models	2120-228
W	Waffle makers	94-95
	Wall-mounted order base	167
	Water boiler	135,137
	Weight indicators	275
	Wine refrigerator	204-206





Ham machines



MA300 *Hand machine (antique style)*

Mistro Volano MA 300 Black meat slicer

- Ideal for finely slicing all types of cold cuts with a minimum cutting thickness of 0.3 mm
- Special built-in knife sharpening mechanism
- Knife safety ring
- High-precision slice thickness adjuster
- Toothed belt drive
- Special base with double product retention bar
- **Ideal for Italian restaurants, delicatessens**



Ideal for Italian restaurants, delicatessens



Base

	Volano MA300	Base
Code	100.0050	100.0055
Blade	300	-
Cutting thickness	0.3 - 5 mm	-
Plate (stainless steel)	235*180mm	-
Dimensions with base	840*620*1330mm	-
Machine weight	73	-
Base weight	48 kg	-
Price	€6,800	€1,800

*Prices do not include VAT. Prices are subject to change without notice.
The company is not responsible for any typographical errors.*

Ham machines

AF VOLANO *Hand-held machine (antique style)*

- Special built-in mechanism for knife sharpening
- Knife safety guard
- High-precision slice thickness adjuster
- Toothed belt drive
- Special base with double product retaining bar
- **Ideal for Italian restaurants, delicatessens**

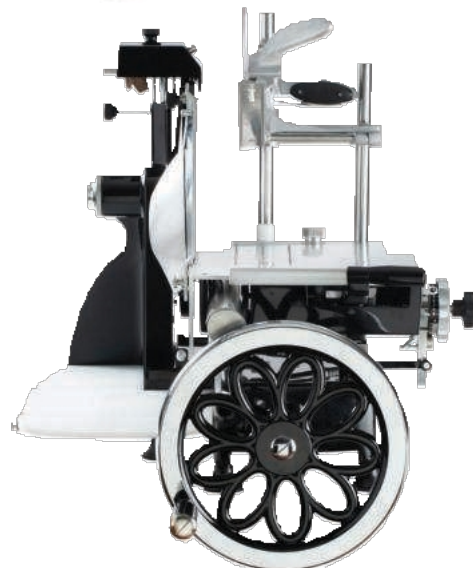

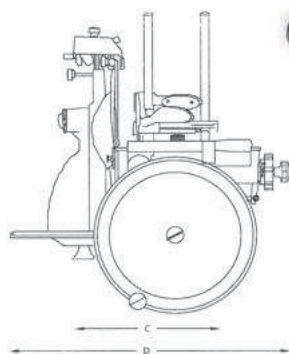
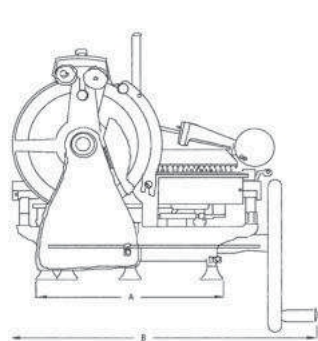
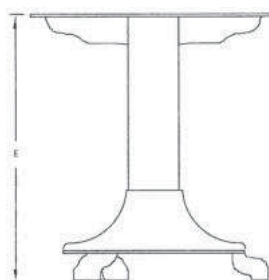

Optional: Ham slicer base

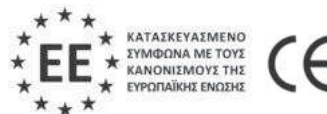

Code	Model	Stand dimensions	Dimensions A*B*C*D*E*F mm	Price
350.0001	AF 300	-	435*720*305*560*560*685	5500€
350.0002	AF 350	-	655*845*400*710*650*775	6,400€
350.0008	Base 300	560*650*720	-	1600€
350.0009	Base 350	650*730*795	-	1600€



Ham machines

VM vertical cut

- Made of anodized aluminum
- Built-in sharpener with special guard that "hides" the knife blade.
- **On/off button with safety relay**
- Slice thickness adjuster 0-16 mm
- Ideal for large prosciutto, pastrami, and roasted meat



Ideal for supermarkets, delicatessens, Italian restaurants

VM 350



VM 300



Code	Model	Power	Power hp	Dimensions	Price
100.0028	VM300	230V/50Hz	0.29	770*530*730	1900€
100.0029	VM 350	230V/50Hz	0.35	830*600*790	3200€

Bread slicers

GS 300 Mini Compact *with belt*

Small ham slicer with excellent cutting performance, ideal for confined spaces.

- Made of anodized aluminum
- Built-in sharpener with special guard that "hides" the knife blade
- **On/off button with safety relay**



Ideal for pizzerias, restaurants, mini markets, bakeries.



Code	Model	Power	Power hp	Dimensions	Price
100.0027	GS 300 CM12 MINI CE COMPACT	230V/50Hz	0.30	500*450*400	1320€





Ham machines

GSX 350 with gear

- Entirely stainless steel construction
- Built-in sharpener with guard that "hides" the knife blade
- **On/off button with safety relay**

 *Ideal for supermarkets, delicatessens, catering, hotels*

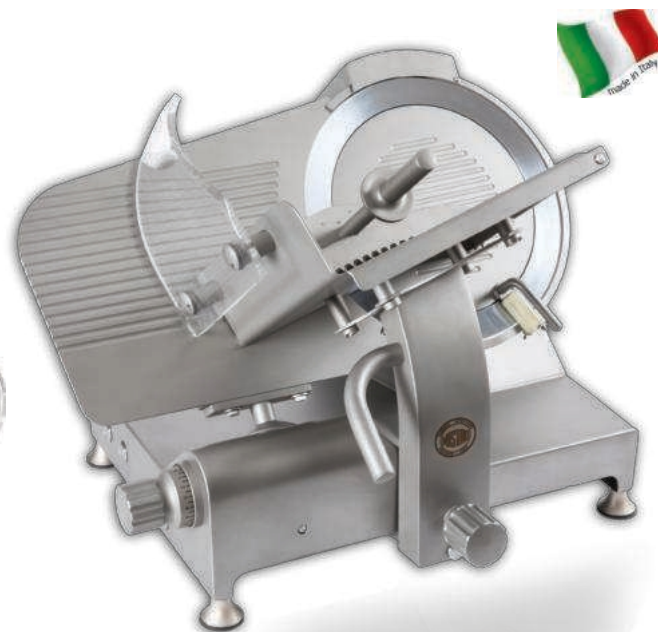

Code	Model	Power	Power hp	Dimensions	Price
100.0013	GSX-350	230/50Hz	0.36	810*850*680	4400€



GS 350 CE with gear

- Made of anodized aluminum
- Built-in sharpener with guard that "hides" the knife blade
- **On/off button with safety relay**

 *Ideal for supermarkets, delicatessens, catering, hotels*



Code	Model	Power	Power hp	Dimensions	Price
100.0025	GS 350 CE	230/50Hz	0.36	810*850*680	3400€



GS 300 EXT Super Quality *with strap*



- Made of anodized aluminum
- Built-in sharpener with guard that "hides" the knife blade
- **On/off button with safety relay**
- Easy to operate
- Cutting thickness 0-16mm

Ideal for pizzerias, restaurants, supermarkets, hotels, mini markets



Code	Model	Power supply	Power hp	Dimensions mm	Price
100.0101	GS300 CE IMANTA SUPER QUALITY EXT	230V/50Hz	0,33	660*510*480	1.600€
100.0011	GS 300 CE RED SUPER QUALITY	230V/50Hz	0,33	660*510*480	1.700€
100.0012	GS 300 CE BLACK SUPER QUALITY	230V/50Hz	0,33	660*510*480	1.700€

GS with strap

- Made of anodized aluminum
- Built-in sharpener with guard that "hides" the knife blade
- **On/off button with safety relay**
- Easy to operate
- Cutting thickness 0-16mm

 *Ideal for pizzerias, restaurants, supermarkets, hotels, mini markets*



Code	Model	Power supply	Ισχύς hp	Dimensions mm	Price
100.0001	GS 250E	230V/50Hz	0,24	565*420*400	900€
100.0002	GS 250E RED	230V/50Hz	0,24	565*420*400	1.100€
100.0003	GS 250E BLACK	230V/50Hz	0,24	565*420*400	1.100€
100.0009	GS 300E	230V/50Hz	0,33	660*510*480	1.460€
100.0020	GS 350	230V/50Hz	0,50	710*520*470	2.200€
100.0022	GS350 BLACK	230V/50Hz	0,50	710*520*470	2.400€

GM 350 SA CE *automatic with belt*



- Entirely stainless steel construction
 - The blade diameter is 35 cm and the blade angle is 40° to facilitate slicing
 - The blade is made of 100 CR6 steel "Made in Italy"
 - Moving parts slide on Teflon rings, allowing smooth and ergonomic movement without tiring the operator.
 - Built-in sharpener that guarantees perfect blade sharpening and clean cutting of the product.
 - Quiet motor
 - Motor cooling with ventilation.
 - Blade rotation with belt.
- Choice between semi-automatic or manual operation
- Semi-automatic operation:** possibility to set the number of slices to be cut, the speed, and the length of the stroke.
- Waterproof panel with low-voltage control buttons and water resistance.
 - Easily removable cover blade and meat plate for easy cleaning.

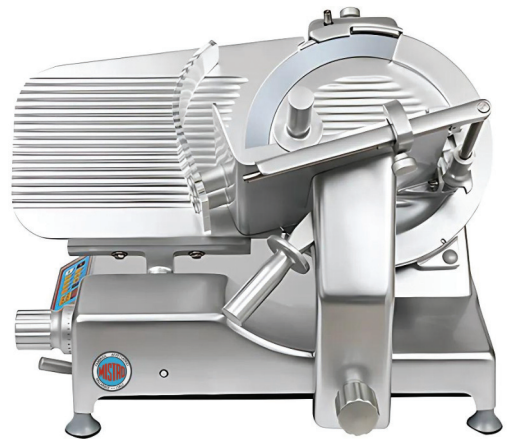

Ideal for pizzerias, restaurants, supermarkets, hotels, mini markets



Code	Model	Power supply	Power hp	Dimensions mm	Price
100.0026	GM 350 SA CE	230V/50Hz	0,35	793*610*485	5.800 €



Ham machines

GS 300 *automatic with belt*

- Made of anodized aluminum
- Built-in sharpener with guard that "hides" the knife blade
- **On/off button with safety relay**
- Cutting thickness 0-16mm

 *Ideal for pizzerias, restaurants, supermarkets, hotels, mini markets*

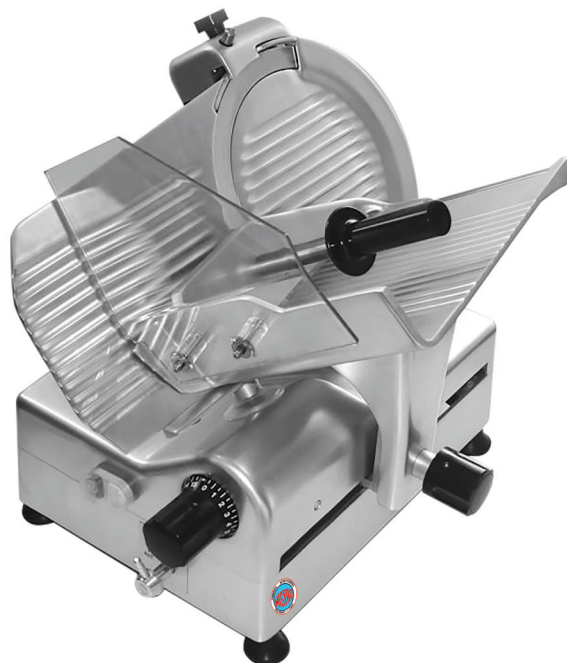

Code	Model	Power supply	Power hp	Dimensions mm	Price
100.0040	GS-300	230V/50Hz	0,33	660*600*650	3.200 €



GM 350 *with strap*

- Made of anodized aluminum
- Built-in sharpener with guard that "hides" the knife blade
- **On/off button with safety relay**

 *Ideal for Supermarkets, Delicatessens, Catering, Hotels*



Code	Model	Power supply	Power hp	Dimensions mm	Price
100.0023	GM-350	230V/50Hz	0,36	810*850*680	3100 €



Ham machines

AF 350 *with gear & scales*

- Made of anodized aluminum
- **On/off button with safety relay**
- Slice thickness adjuster 0-16 mm
- Built-in sharpener with guard that "hides" the knife blade
- **With built-in scale with 4 kg weighing capacity**



Ideal for pizzerias, restaurants, supermarkets, hotels, delicatessens, catering

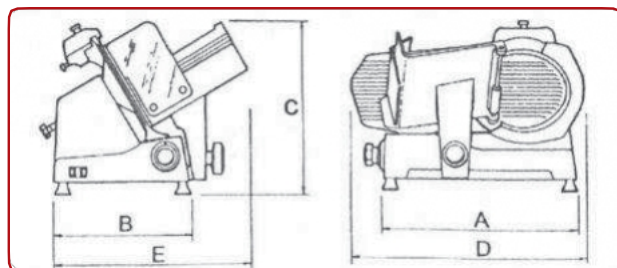
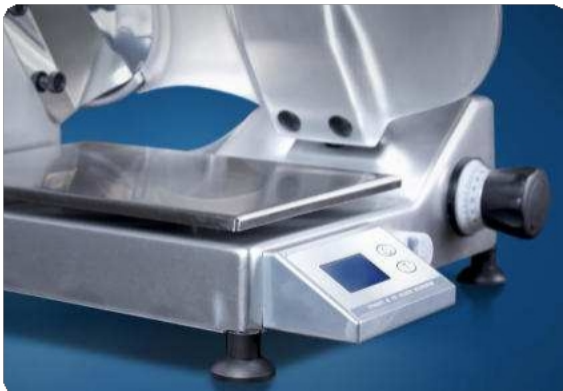

Code	Model	Power	Power hp	Dimensions A*B*C*D*E mm	Price
350.0053	AF 350	220V/50Hz	0.50	A620*B450*C620*D850*E580	5,000€

Ham machines

350 IK Dual *with gear*

- High-quality aluminum for easy cleaning
- Heavy-duty machine
- Built-in sharpener with guard that "hides" the knife blade
- Special handle design for easy movement
- Heavy-duty motor
- **IP X5 motor (waterproof)**
- **IP X3 electrical protection**
- 200 rpm
- Protective cover for motor and relay
- **Waterproof ON/OFF button with safety relay**
- Motion is transmitted by gear

 *Ideal for supermarkets, delicatessens, catering, hotels*



With special cheese knife

Optional: Also available with wide belt

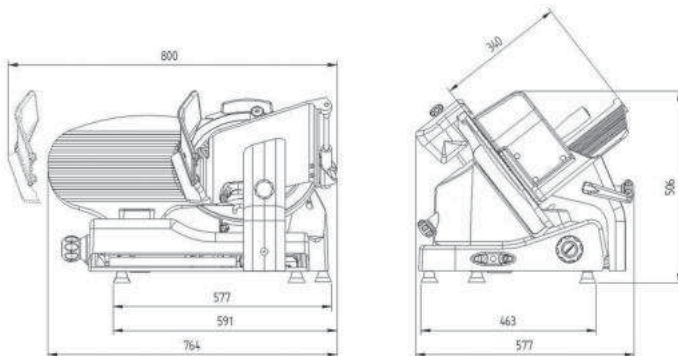

Code	Model	Power	Power hp	Dimensions	Price
110.2002	350IK Dual (belt)	230/50Hz	0.50	800*577*506	4600€
110.2001	350IK Dual (gear)	230/50Hz	0.50	800*577*506	5300€

Ham machines

330 IK *Automatic with gear & meter*

- High-quality aluminum for easy cleaning
- Heavy-duty machine
- Automatic operation with piece counter
- 200 rpm
- Built-in sharpener with guard that "hides" the knife blade
- Special handle design for easy movement
- **IP X5 motor (waterproof)/IP X3 electrical protection**
- Cuts any product automatically or manually using natural gravity
- Thickness regulator 0-24mm

 *Ideal for supermarkets, delicatessens, catering, hotels*

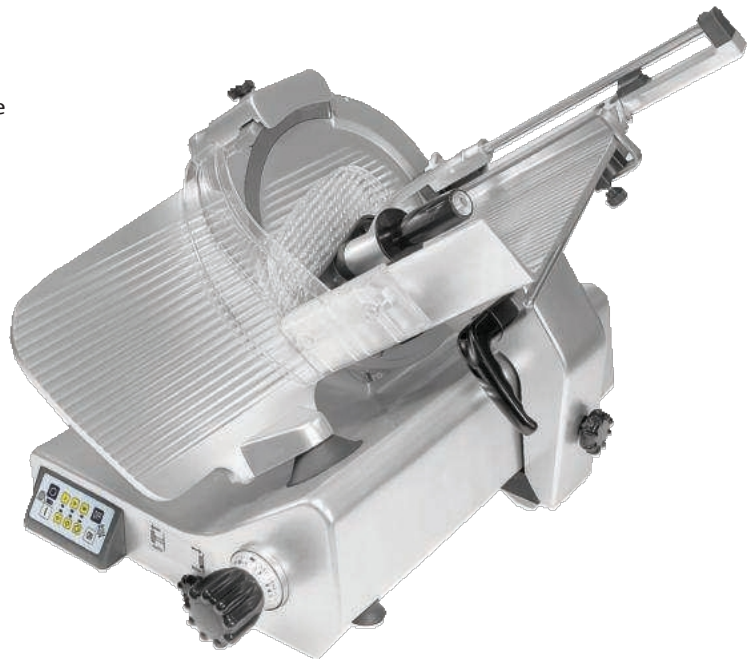

Console

- Piece counting
- Adjusts distance
- Adjusts speed

With automatic shut-off system

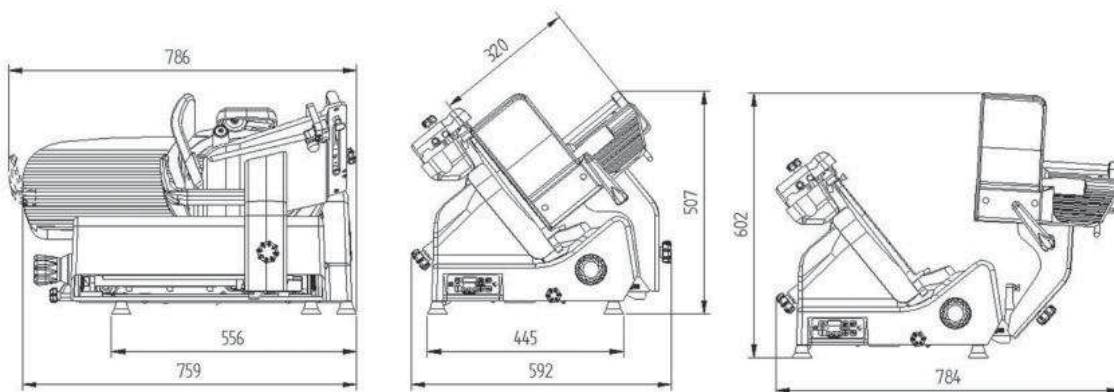

Code	Model	Power	Power hp	Dimensions	Price
110.2004	330IK	230/50Hz	0.50	556*759*445	10,000€

Ham machines

300 IK *with gear*

- High-quality aluminum for easy cleaning
- Heavy-duty motor
- Special frame construction for easy movement
- Protective cover for motor and relay
- Built-in sharpener with guard that "hides" the knife blade
- 200 rpm
- **IP X5 motor (waterproof)**
- **Electrical protection IP X3**
- Easy to operate
- **Waterproof ON/OFF button with safety relay**
- Motion is transmitted by gear
- Slice thickness adjuster 0-24mm

 *Ideal for supermarkets, delicatessens, catering, hotels*



With special cheese knife

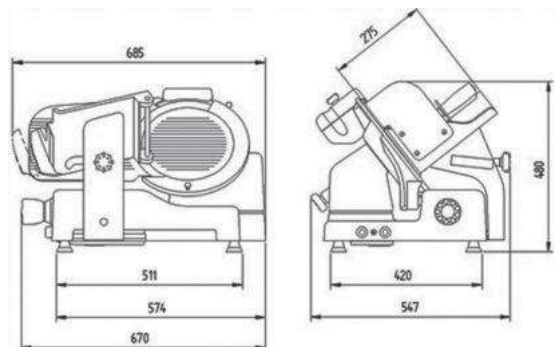

Code	Model	Power	Power hp	Dimensions	Price
110.2000	300IK	230/50Hz	0.50	670*547*480	4300€



Ham machines

Automatic with TENERIFE meter *with strap*

- Made of anodized aluminum and automation components of AISI 304 stainless steel
- It has two motors, one for rotating the knife and one for moving the platform
- Built-in sharpener with a guard that "hides" the knife blade
- The electric counter automatically cuts the number of slices using natural gravity
- It has a platform speed regulator from 34-46 slices/minute (slow-fast)
- Additional armrests for the operator to hold the products
- Features a touch keyboard with LCD screen and backlight
- Easy to clean
- Metal guard for the motor and blade
- Protective cover for motor and relay
- Slice thickness adjuster 0-14 mm
- **ON-OFF switch with safety relay**

 *Ideal for supermarkets, delicatessens, catering, hotels*



Easy to switch from manual to automatic and vice versa

Console

- Piece counting
- Adjusts distance
- Adjusts speed

BELT

Code	Model	Power supply	Power hp	Price
006.0000	TENERIFE TGN 300	230V/50Hz	0.31	4,350€

Dimensions A*B*C*D*E*F*H mm

TENERIFE TGN300 with belt A690*B540*C480*D340*E585*F80*H620

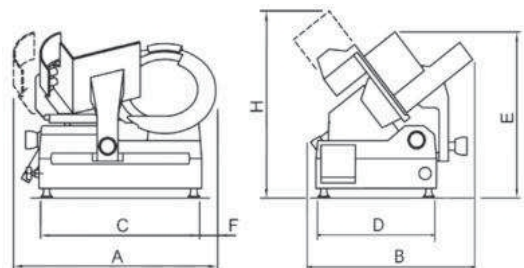

Ham machines

Automatic with KEA & LINOSA meter *with gear*

- Made of anodized aluminum and automation section made of AISI 304 stainless steel
- It has two motors, one for rotating the knife and one for moving the platform
- Built-in sharpener with guard that "hides" the knife blade
- The electric meter automatically cuts the number of slices using natural gravity
- It has a platform speed regulator from 34-46 slices/minute (slow-fast)
- Additional arms for holding products by the operator
- Features a touch keyboard with LCD screen and backlight
- Easy to clean
- Metal guard for the motor and relay
- Protective cover for motor and relay
- Slice thickness adjuster 0-14 mm
- **ON-OFF switch with safety relay**

Ideal for supermarkets, delicatessens, catering, hotels



Easy switch from manual to automatic and vice versa

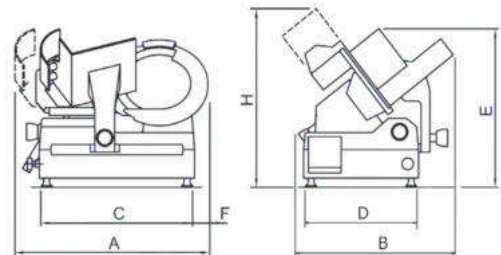

- Console**
- Piece counting
 - Adjusts distance
 - Adjusts speed

GEAR

Code	Model	Power supply	Power hp	Price
006.0002	LINOSA TGI 350	230V/50Hz	0.5	7,500€
006.0001	KEA TGI 350	230V/50Hz	0.34	4,850€

Dimensions A*B*C*D*E*F*H mm

LINOSA TGI350 A810*B600*C600*D450*E610*F70*H700

KEA TGI350 with gear A690*B540*C500*D3500*E550*F90*H600



Ham machines

Mytilana 300 *with gear*

- Made of anodized aluminum
- Built-in sharpener with guard that "hides" the knife blade
- **On/off button with safety relay**



Ideal for supermarkets, delicatessens, catering, hotels

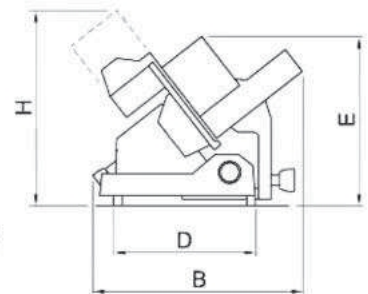
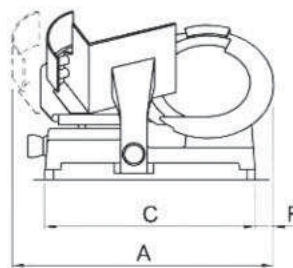

Code	Model	Power	Power hp	Dimensions A*B*C*D*E*F*H	Price
006.0003	MYTILANA 300 GEAR	230/50Hz	0.50	690*540*500*350*450*80*500	3200€

Ham machines

MS-250 / MS-300



- Made of anodized aluminum
- **On/off button with safety relay**
- Easy to operate
- Built-in sharpener with guard that "hides" the knife blade

MS-250 Cutting thickness: 0-10mm

Knife diameter: 250mm

MS-300 Cutting thickness: 0-15mm

Knife diameter: 300mm

Ideal for pizzerias, mini markets, delicatessens.



Code	Model	Power supply	Power hp	Dimensions mm	Price
300.0233	MS-250	230V/50Hz	0,32	490*390*380	540 €
300.0232	MS-300	230V/50Hz	0,42	530*460*460	800 €

SS με ιμάντα

- Made of aluminum alloy
- **On/off button with safety relay**
- Slice thickness adjuster 0-13 mm

Ideal for mini markets, delicatessens, restaurants

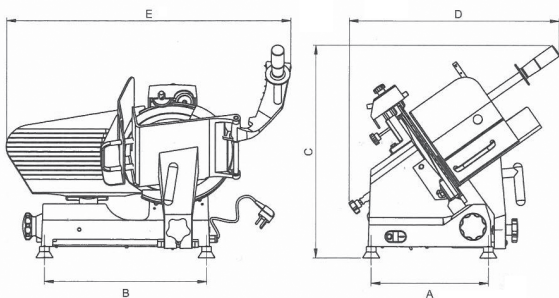

Code	Model	Power supply	Power hp	Dimensions mm	Price
300.0230	SS-250C	230V/50Hz	0,35	A560*B435*C400	720 €
300.0231	SS-300E	230V/50Hz	0,40	A685*B485*C450	1160 €

Linea PRO

Made of aluminum with an innovative coating in accordance with Moca standards, resistant to surface scratches, easy to clean with non-toxic detergents available on the market. The blade has patented non-stick grooves.

- Powerful motor, quiet
- Slice thickness adjuster 0-14 mm
- Equipped with thermal protection
- Easy to use
- Excellent for cutting cold cuts, cheese, and delicatessen products.



Ideal for pizzerias, mini markets, delicatessens, restaurants



LINEA PRO-250



LINEA PRO-275



LINEA PRO-300 COMPACT



Code	Model	Power supply	Power	Dimensions mm	Price
002.0004	LINEA PRO-250	230V/50Hz	0.25Hp	300*440*410*510*390	900€
002.0005	LINEA PRO-275	230V/50Hz	0.25Hp	300*440*410*530*420	940€
002.0003	LINEA PRO-300 COMPACT	230V/50Hz	0.30Hp	330*480*470*570*470	1100€

Ham machine knives

- Ham slicer knife
- Italian manufacture
- Manufacturer: SB

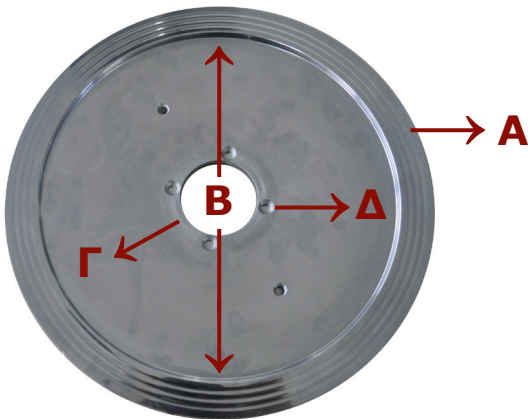

Dimensions knives

- A:** Knife diameter
- B:** Inner diameter
- Γ:** Base diameter knife
- Δ:** Holes (3 or 4)

Code	Model	Dimensions	Price
108.0000	SB 250	A:250 Γ:40 Δ:3 B:210	110€
108.0001	SB 300	A:300 Γ:40 Δ:3 B:245	180€
108.0002	SB 300	A:300 Γ:40 Δ:3 B:250	180€
108.0003	SB 300	A:300 Γ:40 Δ:3 B:254	170€
108.0004	SB 300	A:300 Γ:40 Δ:4 B:254	190€
108.0005	SB 300	A:300 C45 Γ:57 Δ:4 B:254/22,5	220€
108.0006	SB 301	A:301 Γ:55 Δ:4 B:254	170€
108.0008	SB 330	A:330 Γ:57 Δ:4 B:270	220€
108.0009	SB 350	A:350 Γ:57 Δ:4 B:280	210€
108.0010	SB 350	A:300 Γ:57 Δ:4 B:290	200€
108.0012	SB 350	A:350 Γ:57 Δ:4 B:306	240€





Cheese
Oraters Cheese
Cutter

CG55SH cylinder



- Made of special durable aluminum alloy
- Stainless steel product collection bin
- Bottom protection mesh & stainless steel cylinder
- Self-ventilated motor
- **Push button with safety relay**

Ideal for hard cheeses (powder)

Ideal for restaurants, mini markets, and supermarkets



Code	Model	Power supply	Power	Hole diameter	Dimensions mm	Price
300.0210	CG55SH	230V/50Hz	0,75Hp	150*95	495*325*500	800 €

GF DAKOTA

Ideal for hard cheeses (powder)



- Heavy-duty stainless steel & anodized aluminum handle & stainless steel cylinder
- Large grinding opening & large container
- Plexiglass with handle for collecting the product
- High performance - no damage
- **Push button with safety relay**

Ideal for restaurants, mini markets, and supermarkets

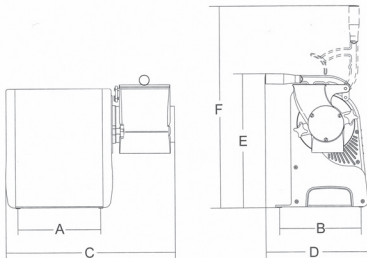

Code	Model	Power supply	Power	Rotations	Hole diameter	Dimensions A*B*C*D*E*F mm	Price
020.0421	CF DAKOTA	230V/50Hz	1Hp	1400	140*80	225*215*500*300*400*580	1500 €



Cheese graters cylinder

Ideal for hard cheeses (powder)

- Stainless steel cheese grater
- Stainless steel bucket for collecting cheese
- **Push button with safety relay**



Ideal for Supermarkets, Delicatessens, Restaurants



Cheese grater cylinder inox mini



Cheese grater cylinder inox mini

Περιλαμβάνει Ιnox κύλινδρο



Cheese grater cylinder inox

Περιλαμβάνει Ιnox κύλινδρο



Code	Model	Power supply	Power	Hole diameter	Dimensions mm	Price
061.0000	Cylinder	230V/50Hz	1,00Hp	80*140	320*420*400	1200 €
061.0001	Cylinder mini	230V/50Hz	0,50Hp	65*110	250*280*310	500 €
061.0002	Cylinder mini λευκό	230V/50Hz	0,50Hp	65*110	250*280*310	470 €
Spare parts						
061.0014	Cylinderinox 1hp	-	-	-	-	150 €
061.0015	Cylinder inox mini	-	-	-	-	80 €

GG HP4

Ideal for hard cheeses (powder)

- Heavy-duty cheese grater cylinder
- Stainless steel cylinder
- Plexiglass container for collecting the product
- **Button with safety relay & industrial-type emergency stop**



Ideal for supermarkets, cheese shops, delicatessens



Περιλαμβάνει Ιnox κύλινδρο

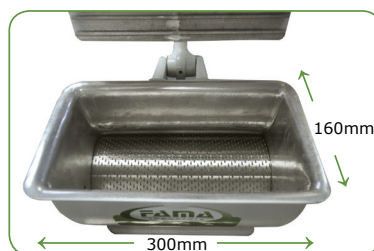

Code	Model	Power supply	Power	Capacity	Hole diameter	Rotations	Dimensions mm	Price
061.0006	GGHP4	380V/50Hz	4Hp	120Kg	300*160mm	1400	A700*B400*C600	4.800 €

GFX HP2

Ideal for hard cheeses

- Stainless steel cylinder
- Equipped with a product collection bin
- Safety switch on the handle
- All parts that come into contact with the product can be removed and cleaned
- **Push button with safety relay**



Ideal for supermarkets, cheese shops, delicatessens



Περιλαμβάνει
Inox κύλινδρο



Code	Model	Power supply	Power	RPM	Mouth dimension	Dimensions A*B*C mm	Price
020.0424	GFX HP2	230V/50Hz	2Hp	140	190*95	185*460*420	2500€
020.0420	GFX HP2	380V/50Hz	2Hp	140	190*95	185*460*420	2400€

GFX-GF

Ideal for hard cheeses

- Made of anodized aluminum
- Stainless steel cylinder
- High-performance motor for continuous operation
- Large plexiglass container for collecting cheese
- Safety switch on the collection container
- **Button with safety relay & industrial-type emergency stop**



Ideal for supermarkets, cheese shops, delicatessens

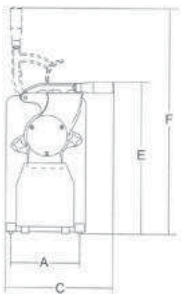

Code	Model	Power supply	Power	Rotations of outlet	Dimensions A*B*C*D*E*F mm	Price
020.0423	GFX-GF	380V/50Hz	4Hp	140	340*700*640*750*640*1100	upon request

Cone-cylinder cheese grater



- It is a combination of two cheese graters: a cone and a cylinder
- **Button with safety relay**
- With safety switch on the lid
- **The machine is designed for grating all types of soft and hard cheeses**

Ideal for pizzerias, mini markets, and supermarkets



061.0012 061.0010 061.0013 061.0011

cones 150€/piece



Περιλαμβάνει
Inox κύλινδρο



Code	Model	Power	Power	Output/hour	Spout Dimensions	Dimensions mm	Price
061.0003	Cone cylinder	230V/50Hz	1Hp	150Kg	80*140	600*290*430	1560€
061.0004	Cone cylinder red	220V/50Hz	1Hp	150	80*140	600*290*430	1640€

Cone cheese grater

- **Button with safety relay**
- With safety switch on the lid
- **The machine is designed for grating all types of soft and hard cheeses.**

Ideal for pizzerias, mini markets, and supermarkets



061.0012 061.0010 061.0013 061.0011

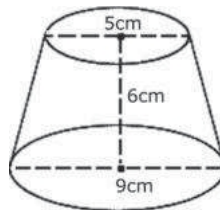

Cone dimensions



Cones 150 € / piece



Code	Model	Power	Power	RPM	Output/hour	Dimensions mm	Price
061.0005	Cone	230V/50Hz	1Hp	140	150	480*250*440	1400€

Multicopters

HLC-300

- Made of special durable aluminum alloy
- With safety microswitch on the handle
- **Push button with safety relay**
- Features a wide variety of stainless steel discs
- Removable lid for easy cleaning
- Cuts and grates cheese, fruit, and vegetables

Ideal for supermarkets, mini markets, pizzerias



Includes 5 different discs

H3, 4, 7 (grinding)

P2, 4 (slicing)



Code	Model	Power supply	Power	Rotations	Dimensions mm	Price
300.0180	HLC-300	230V/50Hz	0,75Hp	600	480*225*580	920€



P P D10x10 HU FM H
for cutting for cutting for cubes for Julienne for powder for soft cheese

Slicing discs

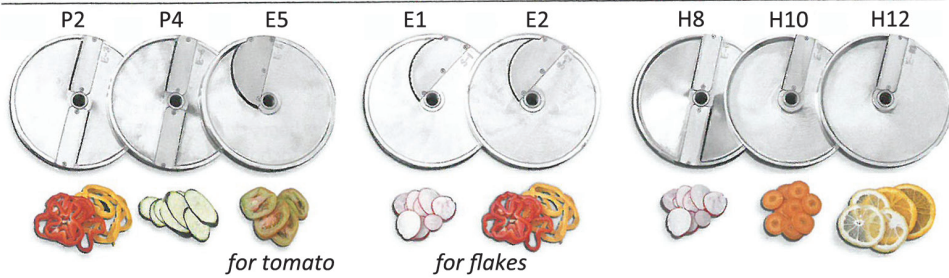

Cutting Set for cubes

Cutting Set for sticks

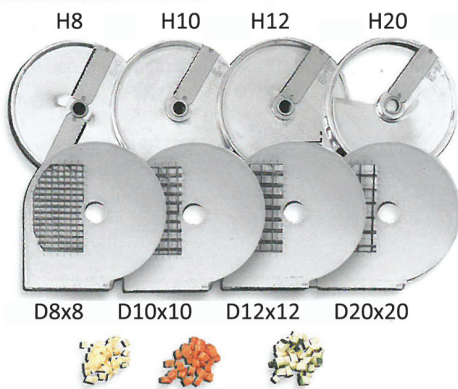

D8x8 D10x10 D12x12 D20x20

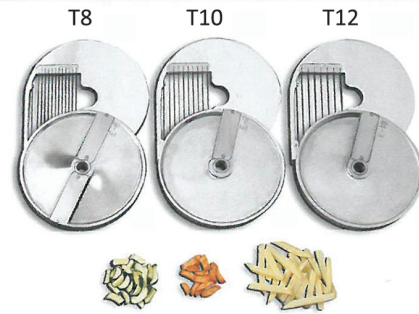

Cutting Set for Julienne

Grinding discs

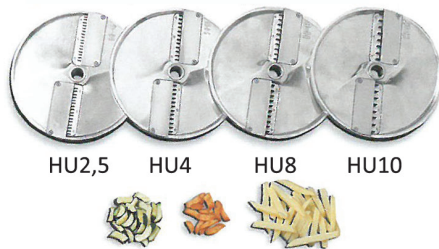

HU2,5 HU4 HU8 HU10

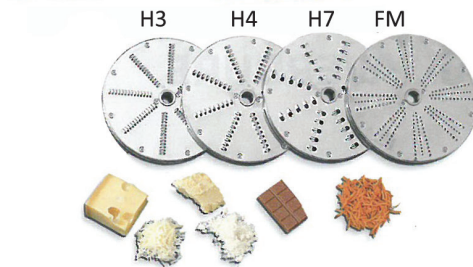

H3 H4 H7 FM



Code	Cutting discs	Price
300.0182	E 1 curved(flakes)	80.00€
300.0183	E 2 curved (flakes)	80.00€
300.0184	P 2 normal	95.00€
300.0185	P 4 normal	95.00€
300.0186	E 5 curved (tomato)	80.00€
300.0187	H 8 normal	95.00€
300.0188	H 10 normal	95.00€

Code	Grinding discs	Price
300.0197	FM for powder	70.00€
300.0198	H 3 macaroni	70.00€
300.0199	H 4 macaroni	70.00€
300.0200	H 7 macaroni	70.00€

Code	Julienne Discs	Price
300.0190	HU 2,5	120.00€
300.0191	HU 4	120.00€
300.0192	HU 8	120.00€
300.0193	HU 10	120.00€

Code	Cube discs*	Price
300.0201	D 8x8	150.00€
300.0202	D 10x10	150.00€
300.0203	D 12x12	150.00€
300.0204	D 20x20	150.00€

Code	Sticks Discs*	Price
300.0194	T 8	120.00€
300.0195	T 10	120.00€
300.0196	T1 2	120.00€

* For cube discs & stick discs, a combination with the cutting disc series H must be used.

Multicopters

VC65MS

- Made from a special durable aluminum alloy
- With safety microswitch on the handle
- **Button with safety relay**
- Cuts and grates cheese, fruit, vegetables
- Comes with a wide variety of stainless steel discs
- Removable lid for easy cleaning

Ideal for restaurants, hotels, pizzerias, grill houses & food processing industries



Includes 5 different discs G3,5,7 (grating) SP2, 4 (slicing)

Model	Model	Power	Power	RPM	Mouth dimensions	Dimensions	Price
300.0181	VC65MS	230V/50Hz	1Hp	30	0.55-0.165	480*225*580	1200€



Cutting discs for vegetables

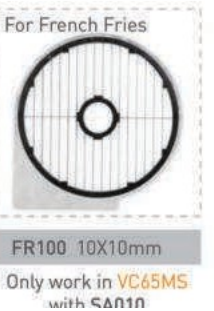
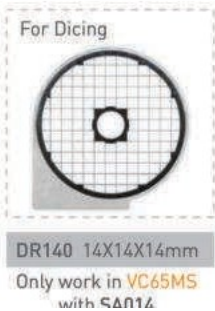
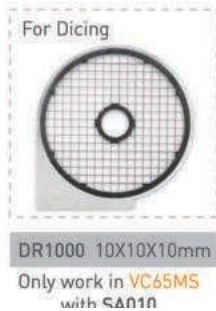

Prices do not include VAT. Prices are subject to change without notice. The company is not responsible for any typographical errors.

Cutting discs



Code	Cutting Discs	Price
300.0507	3 blades SA002 2mm alum	95€
300.0508	2 blades SA004 4mm alum	95€
300.0509	2 blades SA006 6mm alum	95€
300.0510	1 blade SA008 8mm alum	95€
300.0511	1 blade SA010 10mm alum	95€
300.0512	3 blades SP002 2mm plast	70€
300.0513	2 blades SP004 4mm plastic	70€
300.0520	1 blade SA014 14mm	80€
300.0521	Curved blade SS002 2mm	80€
300.0522	Curved blade SS004 4mm	80€
300.0523	Curved blade SS010 10mm	80€
300.0531	Crimping WA005	30€
300.0532	Base for cutting discs	40€

Code	Julienne discs	Price
300.0514	J 3x3mm	120€
300.0515	J 4x4mm	120€



Code	Grating discs	Price
300.0501	V001 1mm	70€
300.0502	G002 2mm	70€
300.0503	G003 3mm	70€
300.0504	G005 5mm	70€
300.0505	G007 7mm	70€
300.0506	G010 10mm	70€

Code	Cube discs*	Price
300.0526	DR 8x8	150€
300.0527	DR 10x10	150€
300.0528	DR 14x14	150

Code	Sticks discs*	Price
300.0524	FR 8x8	140€
300.0525	FR 10x10	140€

Code	Knife holder	Price
300.0535	Disk Holder	40€

* For cube discs & stick discs, a combination with SA series cutting disc must be used.

Multicopters

TM2 Inox

- With safety microswitch on the handle
- **Push button with safety relay**
- Ventilated motor for continuous operation
- Accepts a wide range of discs for every result
- Collection bucket with safety contact
- Cuts and grates cheese, fruit, and vegetables.

 *Ideal for restaurants, grill houses, pizzerias, supermarkets, hotels*



**Cuts soft products
such as mozzarella
cheese and tomatoes**

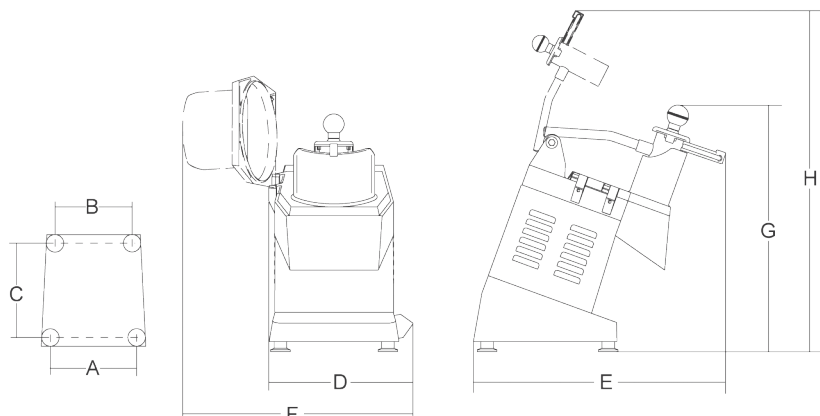

Code	Model	Power supply	Power	Rotations	Dimensions A*B*C*D*F*G*H mm	Price
020.0030	TM2 Inox	230V/50Hz	0,70Hp	300	225*195*255*280*510*510*770	1.520€

Cutting Discs

Slicing discs

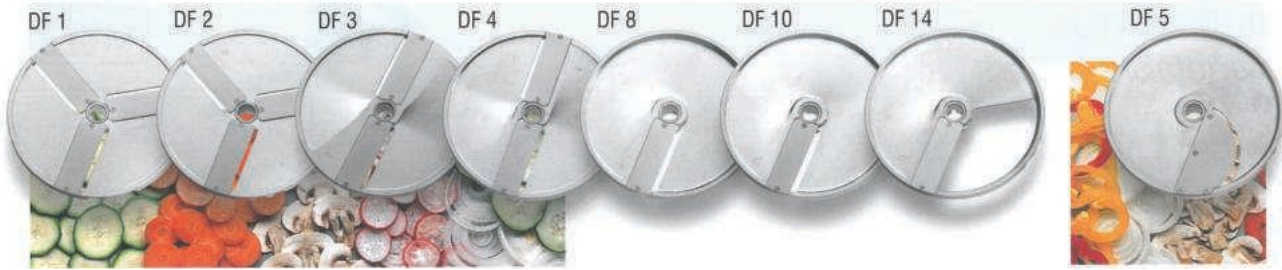

Julienne Cutting Set



Cutting Set for Cubes

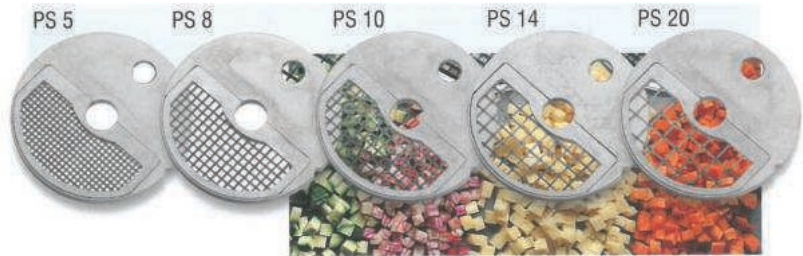

Grating discs



CE

Code	Sliced discs	Price
020.0001	DF 1 1mm	110€
020.0002	DF 2 2mm	100€
020.0003	DF 3 3mm	100€
020.0004	DF 4 4mm	100€
020.0005	DF 8 8mm	100€
020.0006	DF 10 10	100€
020.000	DF 14 14	100€
020.0008	DF 5 convex for tomatoes	100€

Code	Grinding discs	Price
020.0009	DTV 1mm	100€
020.0010	DT 2 2mm	100€
020.0011	DT 3 3mm	100€
020.0012	DT 4 4mm	100€
020.0013	DT 7 7mm	100€
020.0014	DTV 8 8mm	100€
020.0015	DT 9 9mm for mozzarella	100€

Code	Dicing discs	Price
020.00	PS 5 5mm	250€
020.0022	PS 8 8mm	190€
020.0023	PS 10 10mm	180€
020.00	PS 14 14	140€
020.00	PS 20 20	140€

Code	Julienne discs	Price
020.0016	DQ 4 4mm	160€
020.0017	DQ 6 6mm	150€
020.0018	DQ 8 8mm	140€
020.0020	DQ 10 10mm	140€

*** For the PS series, a combination with the DF series cutting disc must be used.**

Multicopters

CHEF MEC 300

- Stainless steel construction
- Cuts and grates cheese, fruit, vegetables
- Sturdy construction, removable lid for easy cleaning
- Wide range of discs

Ideal for restaurants, canteens, pizzerias, supermarkets, and food manufacturers



Digital panel with safety relay



Code	Model	Power	Power Hp	RPM	Mouth dimension	Dimensions A*B*C mm	Price
002.0014	CHEF 300MN	230V/50Hz	0.51	300	190*95	240*570*470	1250€



Cutting



Grinding



Powder



Julienne

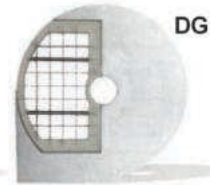

Dice

Code	grinding discs	Price
002.0020	V mm	150€
002.0021	Z 2mm	150€
002.0022	Z 3mm	150€
002.0023	Z 4mm	150€
002.0024	Z 7mm	150€

Code	Julienne discs	Price
002.0040	H 2.5mm	150€
002.0041	H 4mm	150€
002.0042	H 6mm	150€
002.0043	H 8mm	150€
002.0044	H 10mm	150€



Code	Sliced discs	Price
002.0025	S 1mm flakes	150€
002.0026	S 2mm flakes	150€
002.0027	E 3mm	150€
002.0028	E 5mm tomato	150€
002.0029	E 6mm	150€
002.0030	E 8mm	150€
002.0031	E 10mm	150€

Code	Cube discs	Price
002.0050	DG 10+E	230€
002.0051	DG 12+E	230€
002.0052	DG 16+E	230€
002.0053	DG 20+E	230€

*** For cube discs, a combination with a series E cutting disc must be used.**

Cheese cutters

English cheese cutter

- Practical "Handee" device that cuts cheese quickly, easily, and economically without crumbling or waste.
- Made of white melamine specifically for food, it is completely durable and compatible with the chemical composition of cheese.
- The patented floating stainless steel wire (60cm) cuts all types of cheese smoothly and returns to the cutting position after each cut.
- When not in use, the handle is housed in retaining slots, where the wire is kept semi-tensioned and free of kinks.
- Easy wire replacement in seconds.
Cleans with a simple wipe with a damp cloth.
- Comes with a pack of 12 replacement wires.



Code	Model	Power supply	Dimensions mm	Price
101.0100	English Cheese Cutter	Hand	330*280	260€

Cheese Cutter GHIZZONI

- Tabletop stainless steel construction
- Cheese cutting with a blade
- With blade release lever
- Cuts all types of cheese smoothly and returns to the cutting position after each cut.



Code	Model	Power supply	Dimensions mm	Price
107.0010	Inox 42x42	Hand	40*40	390€



Processing meat

Meat grinders

Refrigerated DRC R22 - DRC R32

- Entirely stainless steel construction
- Powerful oil reducer with gears
- **With reverse function**
- Entire machine with IP65 protection
- Control panel with IP54 protection
- Silent motor
- Safety stop
- Unger meat grinder blades



Protective cover for meat tray



DRC R32



Stainless steel: hook, spiral, ring, cutter, knife, sieve, ring

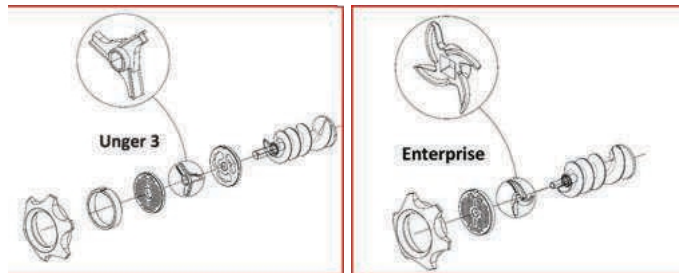

	DRC/22	DRC NO32 UNGER	DRC NO32 ENTERPRISE
Code	101.001	101.0011	101.0012
Dimensions (mm)	419 x 330 x 567	475 x 400 x 617	475 x 400 x 617
Capacity	300kg/h	600kg/h	600kg/h
Power	1.5HP	3HP	3HP
Power supply	Three-phase 380V/50Hz	Three-phase 380V/50Hz	Three-phase 380V/50Hz
Drive	Worm gear reducer	Worm gear reducer	Worm gear reducer
Cutting system	Enterprise	Unger 3	Enterprise
Basic equipment	1 knife, 1 sieve	Cutter, knife, sieve & ring	Knife, sieve
Gas type	R134A 180gr	R134A 200gr	R134A 200gr
Price	4000€	5400€	5000€

DRC 32

- Entirely stainless steel construction
- **With reverse function**
- Entire machine with IP65 protection
- Silent motor
- Safety stop



DRC 32	
Code	101.0016
Dimensions (mm)	620 x 425 x 505
Capacity	600kg/h
Power	3HP / 2.2kW
Power	380V/50Hz
Cutting system	Enterprise
Basic equipment	1 knife, 1 sieve
Price	upon request

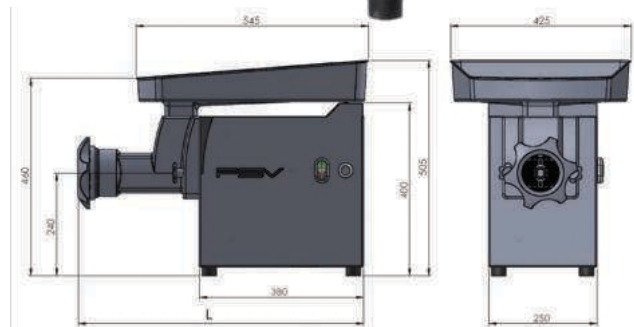

DRC 114 Refrigerated

- Entirely stainless steel construction
- **With reverse function**
- Entire machine with IP65 protection
- Silent motor
- Safety stop



DRC 114	
Code	101.0014
Dimensions (mm)	1000 x 760 x 1250
Capacity	1400kg/h
Power	5.5HP / 4.1kW
Power	380V/50Hz
Cutting system	Unger 3
Basic equipment	1 knife, 1 sieve
Price	upon request



Meat grinders

HFM

- All-stainless steel meat grinder
- **Equipped with reverse switch**
- Steel gear for movement
- Stainless steel bowl, screw, and ring



Ideal for butcher shops and restaurants



	HFM8	HFM12	HFM22 with proctor	HFM32 with protruder
Code	300.0240	300.0241	300.0242	300.0243
Power	0.34Hp	0.75Hp	1.50Hp	2.00Hp
Dimensions mm	565*260*465	565*260*465	645*305*500	645*305*500
Power supply	230V/50Hz	230V/50Hz	230V/50Hz	230V/50Hz
Price	580€	680€	900€	1050€

"UNGER 3" system

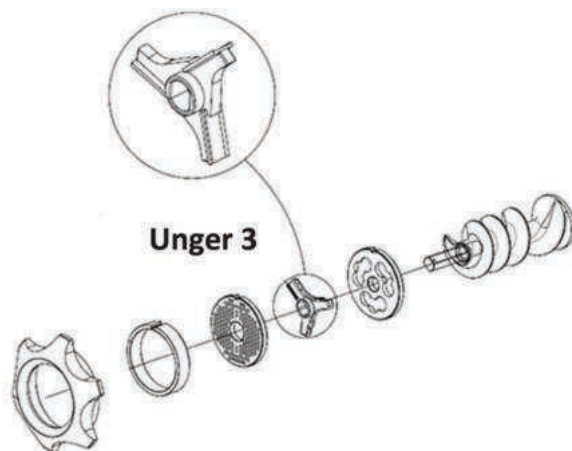

Meat grinders

32 MEC stainless steel

- Stainless steel housing, funnel, and collector
- Bowl, spiral, stainless steel ring
- Self-sharpening blade and knife
- **With reverse function**

Ideal for supermarkets, restaurants, and butcher shops



	32 MEC	32 MEC
Code	360.0002	360.0003
Production	500 kg/hour	500 kg/hour
Rotations	1200 rpm	1200rpm
Power	3Hp	3Hp
Dimensions	520x260x530	520x260x530
Power supply	230V/50Hz	400V/50Hz
Price	2,900€	2,700€



Heavy-duty meat grinders

Montana TC42 Y12

- Heavy-duty, made entirely of stainless steel
- Features stainless steel hook, spiral, and ring
- **With reverse function**
- Powerful oil reducer for better performance
- Wheeled with 4 wheels and brake
- Large stainless steel meat feeding tray
- With safety relay

Ideal for medium-sized meat processing units



Compatible with Enterprise System
Optional unger 5 (prosecutor system)

	TC-42 Y12
Code	020.0500
Production	1500 kg/hour
Power	7Hp
Pan dimensions mm	563*900*120
Power	380V/50Hz
Price	upon request

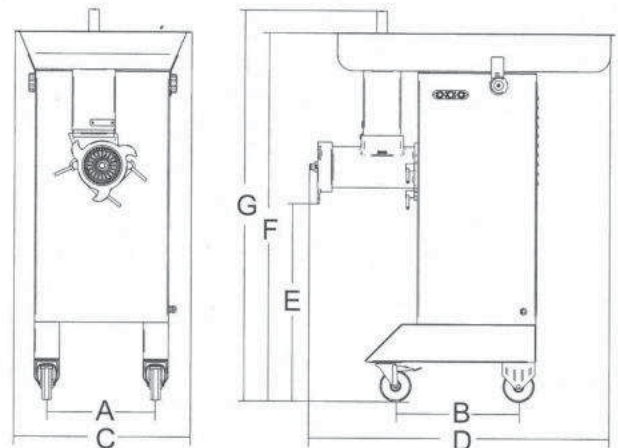
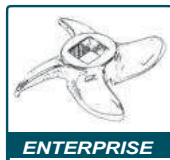

Dimensions

A348*B393*C626*D1125*E631*F1282*G128



Meat grinder knives

Self-sharpening meat slicer knives

- Self-sharpening meat grinder knives
- High durability for professional use
- Made of hard stainless steel
- Ideal for all types of meat grinders



Type FAPATOOLS	MOD. 8	MOD. 12	MOD. 22	MOD. 32	MOD. 42
CODE			108.0106	108.0107	108.0108
PRICE	12.00€	14.00€	18.00€	20.00€	50.00€



Type PATRIZIO	MOD. 8	MOD. 12	MOD. 22	MOD. 32	MOD. 42
PRICE	12.00€	14.00€	16.00€	20.00€	€50.00



Type ENTERPRISE	HFM. 8	HFM. 12
CODE	108.0100	108.0101
PRICE	12.00€	14.00€

UNGER type	HFM. 22	HFM. 32
CODE	108.0103	108.0105
PRICE	30.00€	40.00€

Meat grinder screens

- Finished meat grinder screens
- Highly durable for heavy professional use
- Made of hard stainless steel
- Ideal for all types of meat grinders.



Code	Type FAPATOOLS	Diameter	Price
108.0200	MOD.22	3.5	40.00€
108.0201	MOD.22	4.5mm	32.00€
108.0202	MOD.22	8.0 mm	40.00€
108.0203	MOD.22	12	35.00€
108.0204	MOD.22	14	50.00€
108.0205	MOD.32	3.5mm	52.00€
108.0206	MOD.32	4.5mm	50.00€
108.0207	MOD.32	8.0 mm	60.00€
108.0208	MOD.32	12	60.00€
108.0209	MOD.32	14	55.00€
108.0210	MOD.42	3.5mm	75.00€
108.0211	MOD.42	4.5mm	80.00€

Code	Type JOUF	Diameter	Price
108.0255	MOD.22	4.5	22.00€
108.0257	MOD.22	4.5 mm	32.00€

Sausage Stuffing

Electric sausage stuffer

- Filler for all types of sausage
- Vertical design with electric filling piston
- With foot pedal and up/down direction switch
- Stainless steel construction
- With speed regulator

Ideal for butchers and meat processing plants



Panel



Comes with 4 funnels in different sizes (14.5-20-30-36mm)



Code	Model	Cylinder dimensions mm	Capacity	Weight Kg	Device dimensions mm	Price
300.0648	ESF-15LK	463*262*235	15L	33.2	370*310*760	1200€

Sausage Stuffing

Electric sausage stuffer

- Filler for all types of sausage
- Vertical construction with electric filling piston
- Simple panel, foot pedal operation, automatic plunger return.
- Stainless steel construction
- With speed regulator
- Quiet operation (57db)
- Integrated safety system for overload protection, safety microswitches.
- Manual release in case of power failures



Ideal for butcher shops & meat processing units



Comes with 4 funnels in different sizes (10-20-30-40mm)

Code	Model	Power	Capacity	Weight Kg	Device dimensions mm	Price
008.0013	INS-15EL DELUXE	200	15L	35	260*320*800	2200€

Sausage Stuffing

Sausage cutter

- Made of stainless steel
- Filling device for all types of sausage
- Manual filling
- Sturdy construction, easy to use



Ideal for butcher shops



Comes with 4 funnels in different sizes (10-20-30-35mm)



With 2 speeds (low & fast)



Code	Model	Cylinder dimensions mm	Capacity	Weight Kg	Dimensions mm	Price
300.0640	SF-15N	405*219	15L	22	415*315*770	480€
300.0641	SF-10N	275*219	10L	20	415*315*650	400€
300.0642	SFH-7L	-	7L	13	690*200*210	300€

Sausage Stuffing

Hydraulic fillers for sausages

- Made of stainless steel, easy to clean
- It has three different funnels (diameter 10, 18, 25 mm)
- It has a foot pedal that controls the piston
- Fills sausages in a very short time, regardless of the type of meat
- Operates automatically hydraulically with oil
- Oil indicator light
- The bucket can be removed for easy cleaning
- Floor-mounted with two wheels for easy transport
- Automatic piston return when stopped

 *Ideal for butchers and packaging companies*



Optional: Stainless steel 4 funnels with diameters of 16, 20, 28, 38 mm
Price upon request



	IS15 IDRA	IS25 IDRA	IS35 IDRA	IS50 IDRA
Code	020.0700	020.0701	020.0702	020.0703
Power	0.75Hp	0.75Hp	0.75Hp	0.75Hp
Power supply	380V	380V	380V	380V
Rotations	2800	2800	2800	2800
Bucket capacity	15L	25L	35L	50L
Emptying time	50 min	65 min	85 min	90 min
Piston time	25 min	30 min	55 min	60 min
Dimensions (L*W*H)	490*370*1200	565*450*1160	640*480*1160	730*550*1250
Price	€4,200	€6,300	Upon request	Upon request

Hydraulic filler for sausages

VILLA 25

- Entirely stainless steel construction
- **With reverse function**
- Quiet motor
- Safety stop

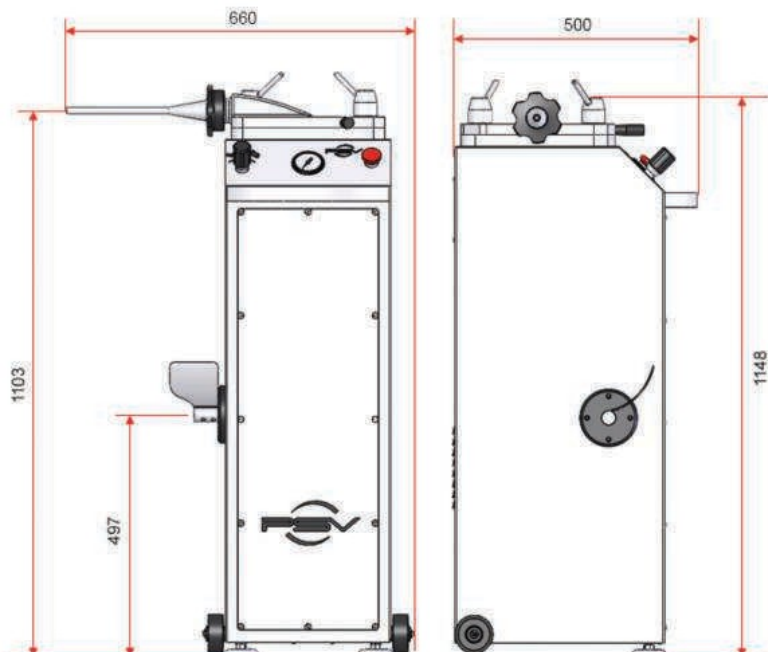

VILLA 25	
Code	101.0015
Dimensions (mm)	660 x 500 x 1148
Capacity	25L - 20Kg
Power	1CV 0.75kW
Power	380V/50Hz
Weight	138 kg
Price	7,000€

Sausage Stuffing

Manual sausage fillers

- Filler for all types of sausage
- Horizontal construction, manual filling
- Sturdy construction, easy to use

Comes with 4 funnels in different sizes (10-20-30-40mm)

Ideal for butchers and packaging companies

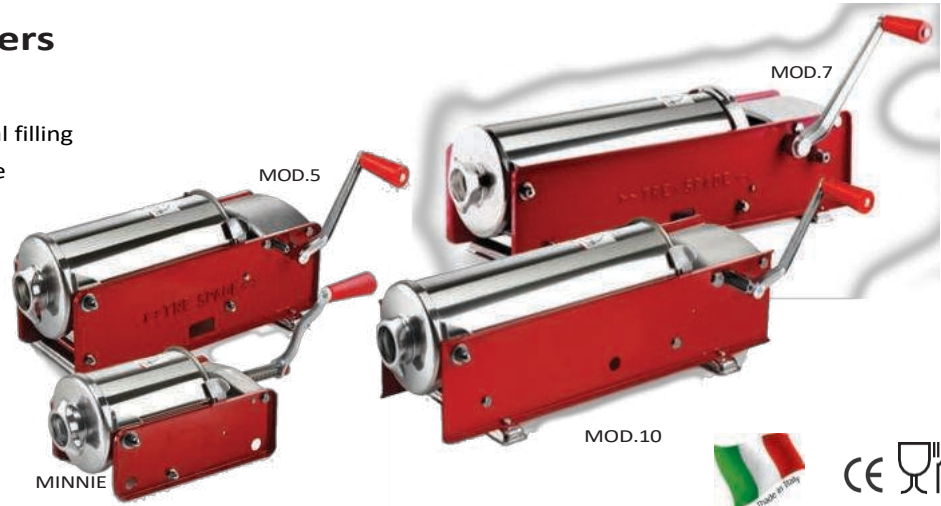

	MINNIE	MOD.5	MOD.7	MOD.10
Code	008.0004	008.0005	008.0006	008.0007
Bin capacity	3L	5L	7L	10L
Weight	5kg	10.5Kg	12kg	17kg
Dimensions mm	360*180*170	530*230*220	600*240*220	730*240*220
Price	260€	440€	520€	620€



Manual stuffers for sausages

- Filler for all types of sausage
- Horizontal construction, manual filling
- Sturdy construction, easy to use

Comes with 4 funnels in different sizes (10-20-30-40mm)



DELUXE MOD.10

DELUXE MOD.5

	DELUXE MOD.5	DELUXE MOD.10
Code	008.0008	008.0009
Bin capacity	5L	10L
Weight	10.5 kg	20.5 kg
Dimensions	530*230*220	730*240*220
Price	560€	800€

Ideal for butcher shops and packaging facilities

Meat stirrer

FMM02 *manual*

- Stainless steel construction
- Aluminum handle
- Plastic cover
- Removable mixing blades
- Easy to clean



Code	Model	Capacity	Power	Dimensions (L*W*H)	Price
300.0140	FMM02	27L	Manual	420*250*360mm	500€

IP 10-20-30M *Electric*

- Tabletop meat mixer with safety relay
- Ideal for all types of meat
- **Reverse button**
- Ideal for butchers, restaurants, hotels.



Code	Model	Power	Power Hp	Capacity Kg	Dimensions mm	Price
	IP 10M	230V/50Hz	0.25	10	A438*B255*C757*D406*E565	1,800€
020.0400	IP 20M	230V/50Hz	0.50	20	A472*B255*C757*D410*E565	3,000€
020.0401	IP 30M	380V/50Hz	1.5	30	A680*B365*C1120*D530*E975	5,000€

Meat stirrer

IP 50-80-120-180 XP BA *Electric*

- Modern design and sturdy construction made of AISI 304 stainless steel
- Rotating wheels made of stainless steel with brake
- Two-arm mixing system
- Removable mixing arms made of AISI 304 stainless steel
- Stainless steel IP67 controls: forward & reverse
- Auto power off function
- Automatic reverse function
- Stainless steel cover with safety microswitch



IP120 XP BA

Ideal for butchers, restaurants, taverns, and small meat processing units

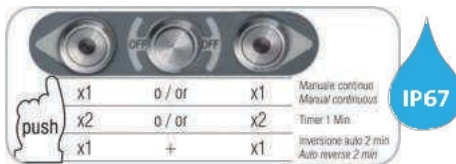

Control Panel



IP50 XP BA



IP80 XP BA



	IP50 XP BA	IP80 XP BA	IP120 XP BA	IP180 XP BA
Code	020.0402	020.04	020.0403	020.0404
Power - Axles	3Hp/2	3Hp/2	3Hp/2	3Hp/2
Power supply	380/50Hz	380/50Hz	380/50Hz	380/50Hz
Bucket dimensions	420*500	620*500	660*550	995*550
Bin capacity	50Kg	80Kg	120Kg	180Kg
Dimensions	810*1617*630	1000*1617*630	1092*1717*700	1422*1030*700
Weight	85	90	138	138
Price	6,200€	7,000€	8,000€	9,000€

Meat mixer

MM55DW *Electric*

- Modern design and sturdy construction of the tank made of AISI 304 stainless steel
- Removable mixing arm made of AISI 304 stainless steel
- Stainless steel cover with safety microswitch
- Forward and reverse switches
- Circuit breaker and thermal motor protection included
- Minimum required load: 30% of maximum capacity ~7kg.



MM55DW



Ideal for butchers, supermarkets, and meat and fish industries

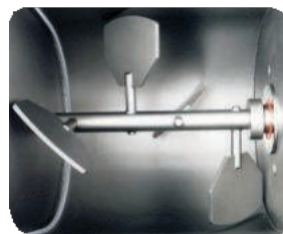

MM75DT

- Made of AISI304 stainless steel
- Gearbox with double oil sealing system
- Oil reducer
- Air-cooled IPX5 motor, suitable for continuous operation
- Safety switch for deactivation when the cover is opened

	MM55DW	MM75DT
Code	300.0141	300.0144
Power/RPM	550W	750W
Power supply	230V/50Hz	230V/50Hz
Capacity	20Kg	30 kg/42 L
Bin dimensions	270*320mm	270*320mm
Dimensions mm	600x380x630	600x380x630
Weight	40kg	40kg
Price	2000€	2350€



MM75DT

Brine pump

PM3

- Stainless steel construction
- Brine pump with 3 needles
- Easy to clean
- With effective ventilation system
- Carrying handle for easy transport

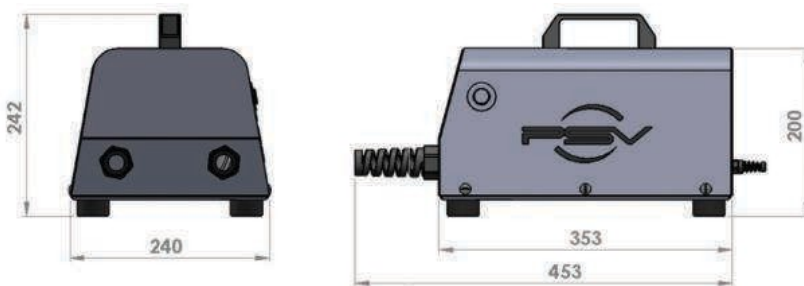

	PM 3
Code	101.0013
Dimensions (mm)	350 x 225 x 240
Capacity	750L/h
Power	0.25kW
Power	230V/50Hz
Pressure	2.5 bars
Weight	11.5 kg
Price	2,800€

Beef Patty Mold

Multipatty

- Practical and sturdy hamburger press with molds
- Made of anodized aluminum alloy
- Available in sizes with a diameter of Ømm 100, 130,150



Code	Model	Diameter	Weight	Price
020.0445	Multipatty	-	7,5Kg	700 €
020.0447	Spare parts	100mm		170 €
020.0449	Spare parts	130mm		180 €
020.0451	Spare parts	150mm		170 €



HB-S130 Multipatty

- Practical & sturdy hamburger press
- Made of anodized aluminum alloy
- Disc (patty) thickness 38mm
- Rubber non-slip feet
- Includes three molds, easy to change.

Mold sizes

- Size 100 mm
- Size 130 mm
- Size 150 mm



Code	Model	Mold diameter	Dimensions	Weight	Price
300.0238	HB-S130	100/130/150 mm	315*255*150mm	6.8Kg	600€



Beef Patty Mold

Mistro

- Choice of 100 and 130 mm diameters
- Solid anodized aluminum construction
- Rubber base for greater stability
- Stainless steel meat disc and mold
- Drive shaft and handle made of stainless steel
- Internal gear made of galvanized C45 steel



Code	Model	Diameter	Weight	Dimensions mm	Price
100.0030	MISTRO 100	100mm	4,0Kg	315x300x300H	500 €
100.0031	MISTRO 100 RED	100mm	4,0Kg	315x300x300H	560 €
100.0032	MISTRO 100 BLACK	100mm	4,0Kg	315x300x300H	560 €
100.0033	MISTRO 130	130mm	4,5Kg	330x300x300H	580 €
100.0034	MISTRO 130 RED	130mm	4,5Kg	330x300x300H	640 €
100.0035	MISTRO 130 BLACK	130mm	4,5Kg	330x300x300H	640 €

Meat grinder Sirman

- Simple and durable press with rounded design
- Made of anodized aluminum alloy
- Stainless steel interior
- Rubber feet for stability



Code	Model	Diameter	Weight	Price
020.0440	No 10	100mm	4,5Kg	490 €
020.0441	No 13	130mm	6,0Kg	590 €
020.0442	No 15	150mm	6,5Kg	590 €

Meat grinder

C-EH SMART Automatic burger press

- Automatic beef mincer
- Made of stainless steel
- Production 1,000 pcs/hour
- Adjustable thickness
- Fast, quiet, and easy to clean

 *Ideal for fast food restaurants, butcher shops, and meat processing plants*

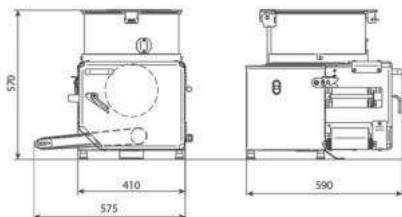

	C-EH SMART
Code	021.0000
Capacity	18Lt
Production/hour	1000
Burger weight	50-120g
Power	0-3Hp
Power supply	380V/50Hz
Weight	48Kg
Price	8,000€

Molds



Code	Diameter	Price
021.0001	10cm	1400€
021.0002	12cm	1400€



Gelatin for meat grinders



ICS WATERPROOF GELATINE SHEETS

Transparent, completely waterproof gelatin sheets for packaging and immediate use. Thickness 60gr. **Not for cooking.**

Code	Diameter	Film color	Price
255.0013	100mm	Transparent	32€/package
255.0014	130mm	transparent	32€/package

1 package = 1kg



ICS GELATINE BEEF/MACHINE PPL

Transparent waterproof gelatin, made of double-coated polypropylene. **Not for cooking.**

Code	Diameter	Film color	Price
255.0015	100mm	Transparent	24€/package
255.0016	130mm	transparent	24€/package

1 package = 1kg



ICS GELATINE BEEF/MACHINE PE

Transparent waterproof gelatin sheets, made of double-coated pink polyethylene for packaging and immediate use. **Not for cooking.**

Code	Diameter	Film color	Price
255.0019	100mm	Pink	20€/package

1 package = 500g



ICS BEEF/MACHINE PAPER NON-STICK PAPER

Waterproof non-stick double silicone paper in disc size and heart and steak shapes. Suitable for use in frying pans and ovens.

 Can also be used in the freezer at 0°-30°C for up to 12 months.



Code	Diameter	Film color	Price
255.0017	100mm	White	14€/package
255.0018	130mm	white	14€/package

1 package = 500gr

ICS BIF/MACHINE PAPER ANTI-STICK PAPER

Waterproof, non-stick double silicone paper in disc size and heart and steak shapes. Suitable for use in frying pans and ovens.



 Can also be used in the freezer from 0°-30°C for up to 12 months.



Code	Diameter	Paper color	Price
255.0020	steak	white	19€/package
255.0021	heart	white	19€/package

1 package = 500gr

Burger machine paper

ICS SEPARATING PAPER (round)

Discs made of special waterproof paper for use in display trays to preserve and prolong the freshness of meat.

Available colors: green, orange, and black.



Code	Diameter	Paper color	Price
255.0022	100mm	Black	20€/package
255.0023	130mm	orange	20€/package
255.0024	100mm	green	20€/package

1 package = 500g



ICS SEPARATOR PAPER FOR MAINTENANCE (shapes)

Storage papers made of special waterproof paper for use in display trays that preserve and prolong the freshness of meat.

Available in heart, steak, flower, rectangle, merlet, and straight shapes. Available colors: green, orange, and black.

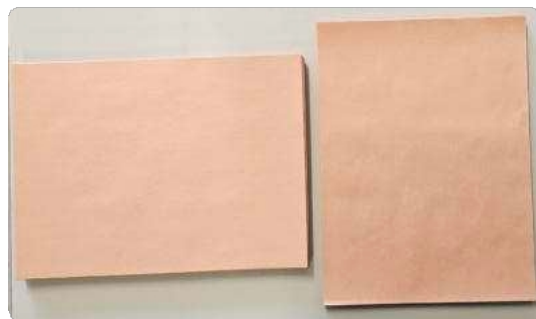

Code	Diameter	Paper color	Price
255.00	steak	black	20€/package
255.0027	flower	green	20€/package

1 package = 500g

255.0028	20x30 merlet	green	30€/package
255.0029	20x30 merlet	black	30€/package
255.0030	20x30 merlet	orange	30€/package

1 package = 500 pieces

255.0031	30x40 Straight	orange	74€/package
----------	----------------	--------	-------------

1 package = 1000 pcs

Slicing machines

BS

- Meat tenderizer
- With safety relay on the lid
- Simple and easy to operate
- Gear-driven
- Parts are easily removed and cleaned



Ideal for supermarkets, butchers, restaurants, and



Optional strip cutting head
8 or 10mm: €580



Code	Model	Power	Power HP	Axis/ Blade	Capacity Cutting	Dimensions (L*W*H)mm	Price
300.0150	BS	230V/50Hz	0.5	2*32	150*30	560*305*560	1,200€

KT PK

- Meat tenderizer
- Made of stainless steel
- With safety relay on the lid
- Removable parts for easy cleaning
- Gear-driven



Ideal for supermarkets, butchers, restaurants, and catering



Code	Model	Power	Power HP	Axes/ Blade	Cutting capacity mm	Dimensions mm	Price
SN-KT-MONO	KT PK	230V/50Hz	0.5	2x37	150x30	560*305*560	3,700€

Slicing machines

T-REX Manual meat tenderizer

- Entirely constructed from stainless steel
- Operates without tearing the meat fibers
- Easy to clean
- Tenderizes an area of 80x210mm with each cycle
- Easy removal and cleaning of blades
- 32 removable blades

👍 *It makes holes for heat to penetrate the meat, ensuring even cooking at different thicknesses. It allows marinades to penetrate deeper. It improves the taste and texture of meat. It reduces cooking time.*

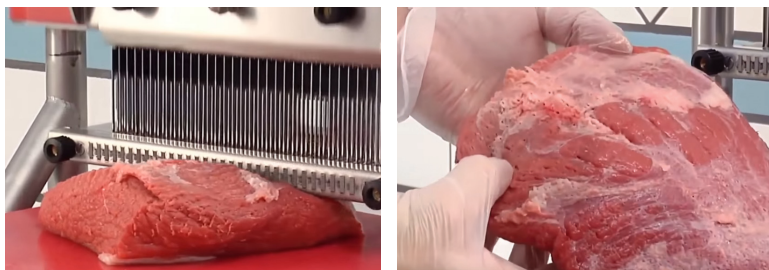

	T-REX
Code	020.0430
Maximum height	100mm
Desktop	30*450
Blades	32
Pounds	25Kg
Dimensions mm	400*450*907
Price	2.600€

Meat tenderizing mallet

VT for tender and juicy meat

Meat tenderizing barrels are used to marinate meat. Place the meat together with the spices in a rotating barrel, set the cycles and time to achieve the best flavor.

- The barrel is made entirely of stainless steel.
- Pump: Feiyue
- With timer

With 3 speeds:

1. Fast speed: 8 seconds rotation & 5 seconds pause
2. Medium speed: 5 seconds rotation & 5 seconds pause
3. Slow speed: 3 seconds rotation & 5 seconds pause



Ideal for meat processing units



VT-2D
Tabletop



VT-38
Wheeled

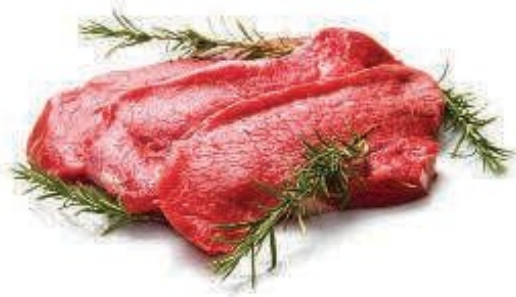

	VT-2D	VT-38	VT-60
Code	300.0644	300.0645	300.0649
Power	230/50Hz	230/50Hz	230/50Hz
Liters	18 liters	38lt	60lt
Power	90W	90W	180W
Vacuum power	240W	240	330
Rotations	27rpm/min	27rpm/min	27rpm/min
Dimensions	620*307*465	750*410*815	890*490*1000
Price	€1,600	€2,100	€2,400

Knife disinfectants

Water sterilizer

- Electric sterilizer that disinfects with water at a temperature of 110°C
- Stainless steel construction and HD polyethylene cover
- Suitable for storing any type of knife
- It operates with two water inlet/outlet connections that are regulated by two taps to prevent any leakage.
- Automatic temperature control at 90°C



Ideal for butchers, supermarkets, meat industries, hotels, and food stores

Code	020.0651
Power	230V/50Hz
Capacity	4
Dimensions	310*140*318
Price	660€



SIRMAN 16 UV lamp disinfectants

- 18/10 stainless steel construction
- 48 cm Plexiglass door
- Removable mesh for holding knives
- Adjustable timer from 0-2 hours
- **The removable transparent case facilitates cleaning and sterilization without the need to rotate the blades.**
- The safety microswitch turns on the lights when the door is closed and turns them off when it is opened.

Code	020.0650
Power	230V/50Hz
Capacity	15 knives
Dimensions	400*140*620
Price	800€



*Ideal for butchers, supermarkets, and industries
Meat shops, hotels, and food stores*



MKS-14

- With UV lamps
- Stainless steel construction
- Plexiglass door
- Wall or tabletop installation

Code	300.0630
Power	230V/50Hz
Time	0-120
Capacity	14-20 knives
Dimensions mm	510*160*600
Price	320€



Ideal for butcher shops, supermarkets, meat industries, hotels, and food stores



Saw blades

CGT Inox

- Hacksaw exclusively for professional use
- Stainless steel workbench
- Special stainless steel blade
- Meat push lever
- Quick release of the upper pulley
- Safety microswitch on the door
- Industrial-type emergency stop
- Push button with safety relay



Ideal for butchers, fishmongers, restaurants, and meat and fish industries

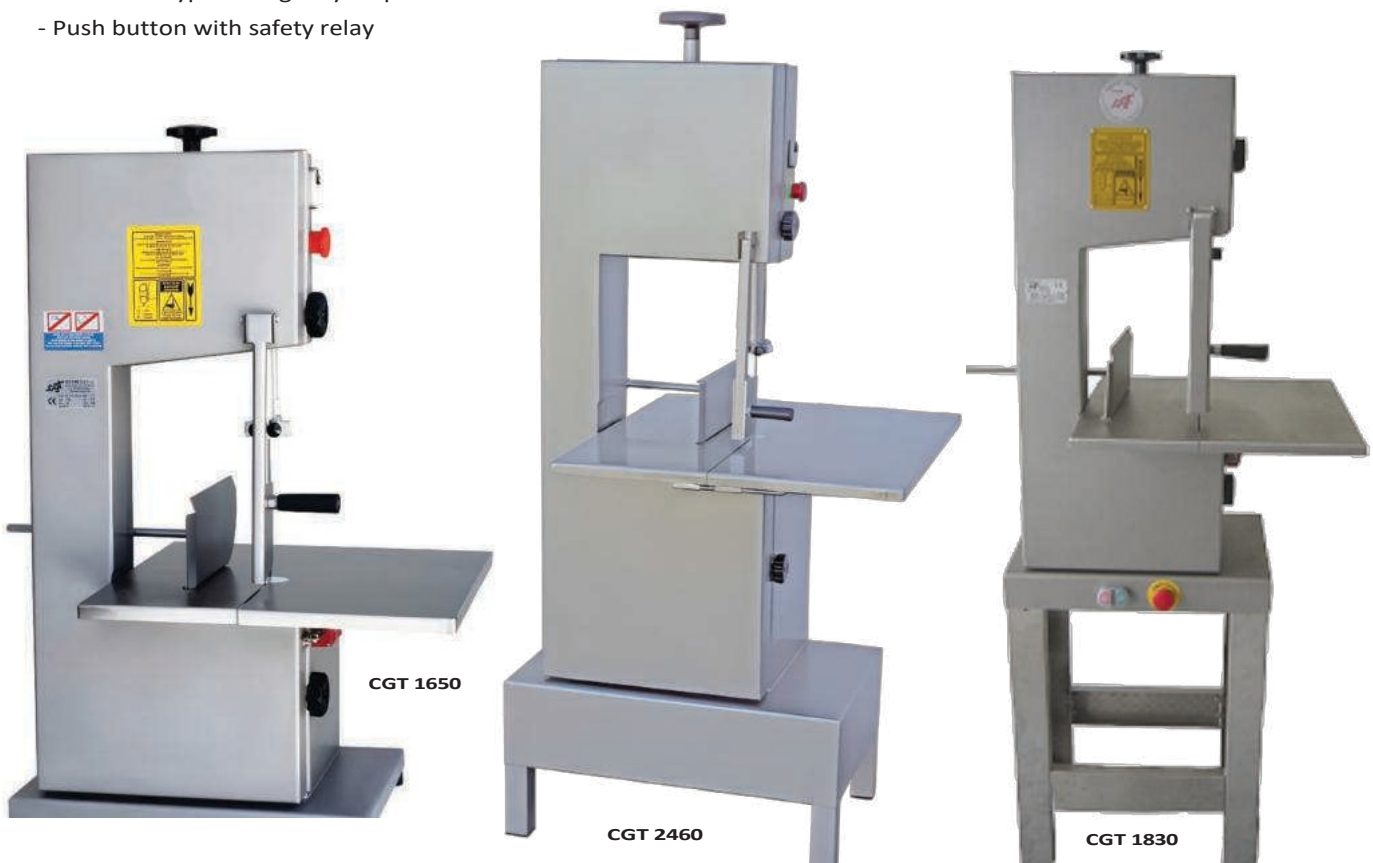

	CGT 1650	CGT 1650	CGT 1830	CGT 1830	CGT 2460	CGT 3160
Code	350.0402	350.0403	350.0404	350.0405	350.0406	350.0407
Power	1.0Hp	1.0Hp	1.5Hp	1.5Hp	1.0Hp	3.0Hp
Power supply	230V	400V	230V	400V	400V	400V
Cutting width	210	210	210	210	285	385mm
Cutting height	260	260	260	260	320	420mm
Bench dimensions	470*485mm	470*485mm	470*485mm	470*485mm	710*650mm	850*800mm
Weight	47	47	67	67 kg	120	157Kg
Price based on	3300 without base	€3200	€3900	€3800	€8300	upon order

Saw blades

CGT Anodized

Heavy-duty band saw, easy to use, with stainless steel workbench and stainless steel blade.

- Meat pusher
- Quick release of the upper roller
- Safety microswitch on the door
- Industrial-type emergency stop
- Button with safety relay

 *Ideal for butchers, fishmongers, restaurants, and meat and fish industries*



	CGT 1830	CGT 1830
Code	350.04	350.0401
Power	1.5Hp	1.5Hp
Power	220V	400V
Cutting width	210mm	210
Cutting height	260	260
Bench dimensions	470*485mm	470*485mm
Weight	55kg	55kg
Price	€2800 based on	€2600 without base

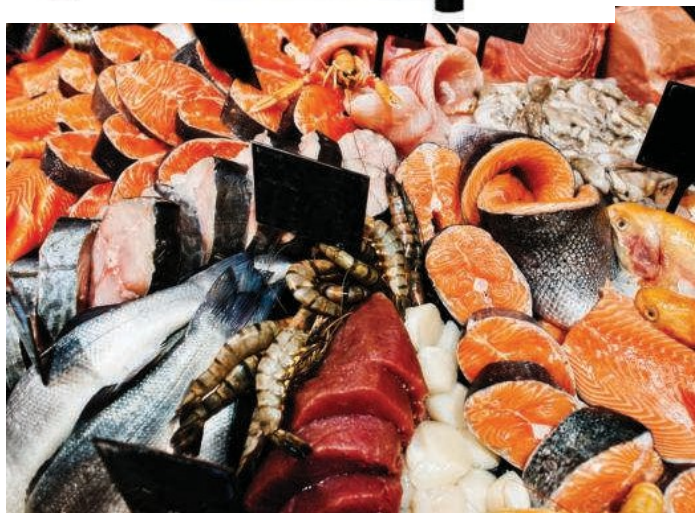

Saw blades

HLS

- Removable blade & pulley made of stainless steel
- Stainless steel blade for cutting frozen fish & meat
- With cutting regulator
- With safety relay

 *Ideal for butchers, fishmongers, restaurants, and meat and fish industries*



	HLS 1650 tabletop	HLS 2020 with base	HLS 2400 with base
Code	300.0254	300.0255	300.0258
Power/RPM	1Hp/1440rpm	2Hp/1440rpm	2Hp/1440rpm
Power supply	230V/50Hz	230V/50Hz	380V/50Hz
Wheel diameter	210	250	300
Saw length	1650	2020	2400
Dimensions mm (W*H*D)	551*566*1023	746*671*1743	875*820*1859
Weight	37kg	116kg	146kg
Price	€1,320	€2,600	€3,000





Meat cutting blades



Wide range of blades for cutting fresh meat such as poultry, pork, beef, and lamb.



MUNKFORS 3 TPI

The blade with 3 teeth per inch can be used for cutting frozen meat with bones, such as pork, beef, lamb, and fish.



MUNKFORS 4 TPI

The blade with 4 teeth per inch is particularly suitable for cutting fresh meat such as pork, beef, lamb, and fish with bones.



HM



This blade has a straight bevel (falchion) on each side of the blade and can be used for various types of products, including fresh fish.



Code	MUNKFORS	Description	Dimension	Price
011.0010	1600	3TRI meat & fish with bones	16*0.50	11.00€
011.0011	16	4TRI fresh meat & fish bones	16*0.50	11.00€
011.0012	16	H Halfmoon DB fresh fish & meat	16*0.50	12.40€
011.0000	1650	3TRI meat & fish with bones	16*0.50	11.00€
011.0001	1650	4TRI fresh meat & fish bones	16*0.50	11.00€
011.0002	1650	H Halfmoon DB fresh fish & meat	16*0.50	12.00€
011.0007	2050	4TRI fresh meat with bone	16*0.50	13.00€
011.0009	1860	4TRI fresh meat with bone	16*0.50	13.00€
011.0020	180	3TRI meat & fish with bones	20*0.50	12.00€
011.0021	180	4TRI fresh meat & fish with bones	20*0.50	12.00€
011.0050	1840	3TRI meat & fish with bones	20*0.50	12.40€
011.0051	1840	4TRI fresh meat & fish with bones	20*0.50	12.40€
011.0060	1960	3TRI meat & fish with bones	20*0.50	12.40€
011.0061	1960	4TRI fresh meat & fish with bones	20*0.50	12.40€
011.0100	2020	3TRI meat & fish with bones	20*0.50	12.40€
011.0101	2020	4TRI fresh meat & fish with bones	20*0.50	12.40€
011.0103	1830	4TRI fresh meat & fish with bones	20*0.50	13.00€

Knife sharpener

CGT

- Knife sharpening with emery belt
- Easy to use
- Knife polishing wheel made of special felt

Clean knives before sharpening.



	CGT	Emery paper	Replacement felt
Code	101.002	101.0021	101.0022
Power supply	230V/50Hz	-	-
Power	0.5Hp	-	-
Price	880€	10€	50€



Ideal for butchers, restaurants, and food industries



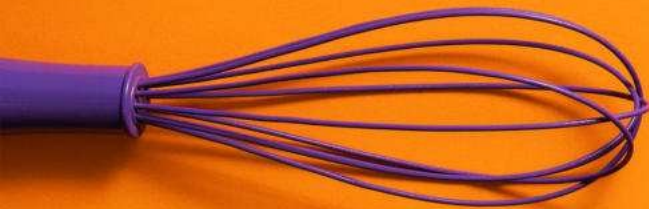

Catering
equipment

Toasters

High efficiency, fast heating, stable temperature, easy control, functional design.



CONTROL ENGINEER
Temperature control
via thermostat switch



PLATO MANTEMIS



CE

Code	Model	Bottom plate	Top plate	Dimension WDH (mm)	Dimension plate mm	Weight	Power	Power Supply	Price
104.0002	GR 4.2			400*430*240	255*245	20 Kg	1.8kW	230V/50Hz	640€
104.0003	GR 4.1L			400*430*240	255*245	20 Kg	1.8kW	230V/50Hz	680€

Toasters

High efficiency, fast heating, stable temperature, easy control, functional design.



CONTROL ENGINEER
Temperature control
via thermostat switch



PLATO MANTEMIS



CE

Code	Model	Bottom plate	Top plate	Dimension WDH(mm)	Dimension plate mm	Weight	Power	Power Supply	Price
104.0004	GR 6.1			510*430*240	365*245	28 Kg	3kW	230V/50Hz	780€
	GR 6.1L			510*430*240	365*245	28 Kg	3kW	230V/50Hz	-
104.0025	GR 6.1LTL			510*430*240	365*245	28 Kg	3kW	230V/50Hz	700€

Toasters

High efficiency, fast heating, stable temperature, easy control, functional design.



CONTROL ENGINEER
Temperature control
via thermostat switch



Vitro
Glass ceramic hob



Code	Model	Bottom plate	Top plate	Dimension WDH (mm)	Dimension plate mm	Weight	Power	Power Supply	Price
104.0012	CG6 SSV	□□□□□□	□□□□□□	470*445*245	340x220	15,5Kg	3.0kW	230V/50Hz	1140€
104.0030	CG6 SSV	□□□□□□	□□□□□□	470*445*245	340x220	15,5Kg	3.0kW	230V/50Hz	1140€
104.0031	CG6 SGV	□□□□□□	□□□□□□	470*445*245	340x220	15,5Kg	3.4kW	230V/50Hz	1160€
104.0000	CG8 SGV	□□□□□□	□□□□ □□□□	640*445*245	2x(220x220)	23,7Kg	3.4kW	230V/50Hz	1500€

Toasters

High efficiency, fast heating, stable temperature, easy control, functional design.



CONTROL ENGINEER
Temperature control
via thermostat switch



PLATO MANTEMIS



Code	Model	Bottom plate	Top plate	Dimension WDH(mm)	Dimension plate mm	Weight	Power	Power Supply	Price
104.0001	GR8.2L	□□□□□□	□□□□ □□□□	690*430*240	550*245	37Kg	3.6kW	230V/50Hz	1000€

PG 400

- Non-stick cast iron plates
- Removable residue collection tray
- With On-Off switch
- Temperature control via thermostat switch
- Temperature range from 50°-300°C



PG 400C



PG 400A



Code	Model	Bottom plate	Top plate	Dimension WDH(mm)	Dimension plate mm	Weight	Power	Power Supply	Price
300.3032	PG 400A			540*480*205	450*300	26 Kg	2800W	230V/50Hz	360€
300.3034	PG 400C			540*480*205	450*300	26 Kg	2800W	230V/50Hz	360€

PG 811

- Non-stick cast iron plates
- Removable residue collection tray
- On-Off switch
- Temperature control via thermostat switch
- Temperature range from 50°-300°C



PG-811A



PG 811C



Code	Model	Bottom plate	Top plate	Dimension WDH(mm)	Dimension plate mm	Weight	Power	Power Supply	Price
300.3030				360*305*205	240*280	12.7Kg	1.8KW	230V/50Hz	250€
300.0034				305*365*210	240*240	12 Kg	1800W	230V/50Hz	250 €

PG 812

- Removable residue collection tray
- Non-stick plates
- With On-Off switch
- Mechanical control
- Temperature adjustment via thermostat switch
- Cast iron plate



CE

Code	Model	Bottom plate	Top plate	Dimension WDH(mm)	Dimension plate mm	Weight	Power	Power Supply	Price
300.0033	PG 812B			430*365*210	360*240	18 Kg	2200W	230V/50Hz	280 €
300.3031	PG 812A			426*360*210	360*285	17.5Kg	2200W	230V/50Hz	280€
300.0035	PG 812C			430*365*210	360*240	18 Kg	2200W	230V/50Hz	280 €

PG 813

- Removable residue collection tray
- Non-stick plates
- With On-Off switch
- Mechanical control
- Temperature adjustment via thermostat switch
- With two independent heating zones
- Cast iron plate



CE

Code	Model	Bottom plate	Top plate	Dimension WDH(mm)	Dimension plate mm	Weight	Power	Power Supply	Price
300.0036	PG 813A			520*365*210	500*240*240	23 Kg	3600W	230V/50Hz	380 €
300.0037	PG 813C			520*365*210	500*240*240	24 Kg	3600W	230V/50Hz	380 €

Electric chrome griddle

Electric chrome hot plate with chrome-plated baking plate and stainless steel construction. Temperature range from 50-300°C and thermostat at 300°C. Features a residue collection drawer. The machine is made of stainless steel, with an elegant design and smooth flat surface, attractive color, and dirt-resistant material for easy cleaning. The high-efficiency system and maintenance of the required temperature ensure easier cooking.

- Stainless steel construction
- Chrome-plated baking plate
- Temperature range from 50-300°C via thermostat
- With residue collection drawer



EG-818D



EG-360D



EG-820D-2



EG-1000D



Code	Model	Cooking surface mm	Dimensions L*W*H (mm)	Power	Power Kw	Price
300.0604	EG-818D Smooth	548*350	550*430*250	230V/50Hz	3	400€
300.0605	EG-818D2 Smooth / Ribbed	548*350	550*430*250	230V/50Hz	3	440€
300.0606	EG-360D Smooth	356*385	460*357*222	230V/50Hz	2	340€
300.0607	EG-820D Smooth	728*400	730*464*245	230V/50Hz	2.2+2.2	560€
300.0608	EG-820D-2 Smooth/Ribbed	728*400	730*470*250	230V/50Hz	2.2+2.2	600€
300.0609	EG-1000D	996*398	1000*520*330	230V/50Hz	6	800€

Electric cast iron hot plates

- Cast iron baking plate
- Temperature range from 50-300°C via thermostat
- With residue collection drawer



VEG-835

Electric double smooth plate



VEG-833

Electric single smooth griddle



VEG-836

Electric double smooth & ribbed griddle



Code	Model	Power	Power Kw	Cooking surface mm	Dimensions (L*W*H) mm	Price
300.0600	VEG-833	230V/50Hz	2.72	500*350	550*400*240	300€
300.0601	VEG-835	230V/50Hz	2*2.2	730*400	730*460*240	400€
300.0603	VEG-836	230V/50Hz	2*2.2	730*400	730*460*240	420€

Grill

- Vitro smooth surface
- Splash guard
- Rounded corners for quick and easy cleaning
- Thermostat with indicator light

Code 104.0033

Electric Grill Power supply:
230V/50Hz **Power:** 3.5Kw
Plate dimensions: 355*385
Dimensions: 410*530*250mm
Weight: 10Kg
Price: €900

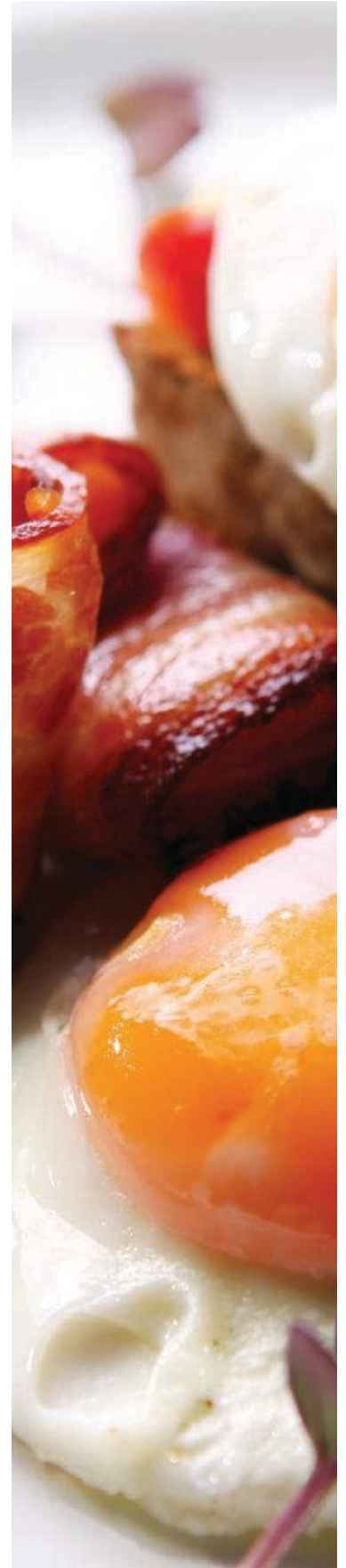

Duplex Grill

- Stainless steel surface, smooth top and bottom
- Protective cover
- Rounded corners for quick and easy cleaning
- Thermostat with indicator light
- With residue collection drawer

Code 104.0032

Electric Grill Duplex Power supply: 230V/50Hz **Power:** 5Kw
Plate dimensions: 355*400
Dimensions: 430x550x350 mm
Weight: 31Kg
Temperature: 0-250 °C
Price: €2000



Potato heaters with infrared rays

- Stainless steel construction
- With two On-Off switches
- Temperature adjustment via thermostat switch
- Heating via infrared system
- With GN1/1 *65mm container
- Non-slip feet to prevent slipping.
- Temperature range: 30-90°C Features a base with a container that keeps French fries warm.



CW-1/1 with infrared



CW-700



Code	Model	Power	Power	Weight	Dimensions (L*W*H)mm	Price
300.0672	CW-2	230V/50Hz	550W	6.7Kg	335*635*580	240€
300.0673	CW-1/1	230V/50Hz	600W	6.1	340*570*437	240€
303.0006	CW-700	230V/50Hz	850W	-	330*270*545	400€

Electric fryers

- Stainless steel construction (201)
- Mechanical control for temperature adjustment
- Switch - Thermostat
- Min-max oil level indicator
- Insulated basket handle
- Easily removable oil tank
- Temperature range 50°C-300°C
- **Safety shut-off due to high temperature**



Ideal for fried foods such as potatoes, chicken, and seafood.



EF-4L
140*210*130mm
Basket dimensions



EF-6L
200*200*110mm
Basket dimensions



EF-8L
200*220*140mm
Basket dimensions



EF-101A
200*220*110
Basket dimensions



EF-11L
200*260*130mm
Basket dimensions



EF-81
180*220*110mm
Basket dimensions



Code	Model	Power	Power Kw	Oil capacity/L	Bucket capacity/L	Dimensions (L*W*H) mm	Price
300.0000	EF-4L	230V/50Hz	2.5	4.5	7.5	220x395x305	160€
300,0001	EF-6L	230V/50Hz	3.0	6	10	265x415x290	170€
300,0002	EF-8L	230V/50Hz	3.25	8	12	265x415x340	190€
300.0006	EF-81	230V/50Hz	3.0	7	10	280x440x315	140€
300.0007	EF-82	230V/50Hz	3.0+3.0	7+7	10+10	570x440x315	240€
300,0008	EF-101A	230V/50Hz	3.0	6.25	10	280x460x305	180€
300.0009	EF-102A	230V/50Hz	3.0	6.25+6.25	10+10	570x480x320	320€
300.0010	EF-11L	380V/50Hz	5	11	14	285*485*335	280€

Electric fryers

- Stainless steel construction (201)
- Mechanical control for temperature adjustment
- Switch - Thermostat
- Min-max oil level indicator
- Insulated basket handle
- Easily removable oil tank
- Temperature range 50°C-300°C
- **Safety shut-off due to high temperature**

Ideal for fried foods such as potatoes, chicken, and seafood.



EF-6L*2
200*200*110
Basket dimensions



EF-8L*2
200*220*140mm
Dimensions basket



EF-11L*2
200*260*130mm
Basket dimensions



EF-82
570*440*315mm
Basket dimensions



Code	Model	Power	Power Kw	Oil capacity/L	Bucket capacity/L	Dimensions (L*W*H) mm	Price
300.0003	EF-4L-2	230V/50Hz	2.5+2.5	4+4	7.5+7.5	442x395x305	320€
300.0004	EF-6L-2	230V/50Hz	3.0+3.0	6+6	10+10	550x415x290	340€
300.0005	EF-8L-2	230V/50Hz	3.25+3.25	8	12+12	550x415x340	380€
300.0007	EF-82	230V/50Hz	3.0+3.0	7+7	10+10	570x440x315	240€
300.0011	EF-11L-2	380V/50Hz	5.0	11+11	14+14	608*515*355	460€

Deep fryers



CE

Model	Code	Production	Oil capacity	Dimensions WDH (mm)	Power supply	Weight	Power kw	Price
FF 6NV	104.0006	10kg/h	5L	265*430*335	230V/50Hz	6.5	3	280€
FF 6+6NV	104.0007	10+10 kg/h	5 + 5L	525*430*335	230V/50Hz	12	3+3	660€

Deep fryers

Bucket equipped with tap for easy emptying of oil.

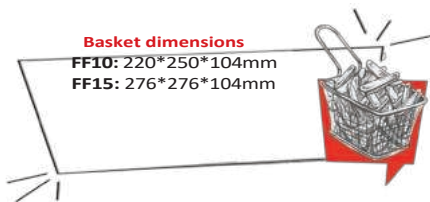

CE

Model	Code	Production Kg/h	Oil capacity	Dimensions WDH (mm)	Power supply	Weight	Power Kw	Price
FF10NV	104.0008	13	8L	265x475x375	230V/50Hz	8 kg	3.5	530€
FF10+10NV	104.0009	13+13	8+8L	525x475x375	230V/50Hz	14Kg	3.5+3.5	880€
FF10+10NV	104.0005	10+10	8L		230V/50Hz			900€
FF15 NV	104.0020	20	10L	325x500x415	380V/50Hz	11Kg	7.5	760€
FF15+FF15NV	104.0021	20+20	10+10L	653x500x415	380V/50Hz	21	7.5+7.5	1300€

Bain Marie

- Stainless steel construction
- With thermostat, temperature range: 30~85°C
- With on-off switch



Ideal for soups, legumes, and vegetables.



BM-1/1 *bain marie*

Code 300.0226

Power supply: 230V/50Hz
Power: 1.2Kw
GN height: 15cm
GN 1/1: 53*32.5
Dimensions: 600*355*260mm
 With water tap
Price: €180



BM-1/2 *bain marie*

Code 300.0227

Power supply: 230V/50Hz
Power: 1.2Kw **GN**
height: 15cm **GN**
1/2: 32.5*26.5
Dimensions: 600*355*260mm
 With water tap
Price: €180



CE

Pasta cooker

The pasta cooker can quickly boil a wide variety of pasta in baskets. Suitable for daily use in professional kitchens.

- The U-shaped heating element provides faster heating
- Made of stainless steel (201)
- Mesh basket dimensions 130*150mm
- Temperature range 30-110°C
- Thermostat-controlled operation



EPC-4
With 2 drain taps
With 4 boiling buckets



Ideal for hotels, restaurants, catering.



EPC-6
With 3 drain taps With 6 boiling buckets



Code	Model	Power	Power Kw	Cooking pot dimensions	Weight Kg	Dimensions (L*W*H) mm	Price
300.0746	EPC-4	230V/50Hz	3	166*345*185mm*2	12.75	480*450*283	440€
300.0745	EPC-6	230V/50Hz	6	166*345*185mm*3	15	690*480*285	520€



Professional egg boiler

- Durable stainless steel construction
- Temperature adjustment via thermostat switch
- Temperature range: 30-110°C
- With 8 colored boiling bases
- With non-slip feet



Code	Model	Egg baskets	Power	Power	Dimensions (L*W*H)mm	Price
303.0603		8	220V/50Hz	2600W	380*295*300	340€

Electric Salamander

- Stainless steel construction
- Temperature range: 50~300°C
- Heating distance 0-140mm
- Suitable for heating food



ES-450L: With 1 temperature control
ES-600L: With 2 temperature controls



Code	Model	Power supply	Power Kw	Επιφάνεια μαγειρέματος	Weight Kg	Dimensions (L*W*H)mm	Price
300.0750	ES-450L	230V/50Hz	2.8	450*330*250mm	37	450*480*500	640€
300.0751	ES-600L	230V/50Hz	4	600*330*250mm	42,5	600*480*520	740€

Electric Salamander

Electric professional grill made of durable stainless steel. The temperature is easily adjustable and it is easy to clean. It is suitable for grilling and reheating food.

- U-shaped heating tube provides faster heating
- Stainless steel construction (SS201)
- Temperature range: 50~300°C
- Rubber feet prevent slipping

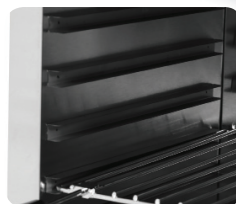

Code	Model	Power supply	Power	Timer	Weight	Dimensions (L*W*H)mm	Price
300.0756	ES-938	230V/50Hz	2.2Kw	30 λεπτά	12Kg	580*435*380	300€

Toaster

- Stainless steel construction
- Baking switch / Timmer
- Manual lever for inserting/removing toast
- With selectable toasting positions for
 - ET-4:** 2 or 4 slices
 - EC-6:** 2, 4, or 6 slices
- Sliding tray for collecting crumbs
- Non-slip feet



ET-4



ET-6



Code	Model	Power	Power Kw	Bread slot	Time	Dimensions (L*W*H) mm	Price
300.0050	ET-4	230V/50Hz	1.8	4	0-5	290*260*220	170€
300.0051	ET-6	230V/50Hz	2.52	6	0-5	420*260*220	200€



Toaster with transport system

Stainless steel construction with double-sided toasting options and adjustable conveyor speed. Standby function for energy saving. Ideal for toasting sliced bread, bagels, croissants, and pastries.



Product inlet



Product removal options



Baking options

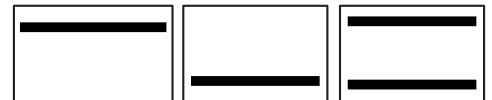

top

down

top-bottom





Code	Model	Power	Power Kw	Chamber dimensions L*W	Dimensions (L*W*H) mm	Price
300.0052	MET-300	230V/50Hz	2.45	265*285 mm	368*418*387	720€
300.0053	MET-450	230V/50Hz	2.6	365*285 mm	468*418*387	820€



RC-16L Rice Cooker

Stainless steel construction

- Non-stick coated inner pot
- LED display for time indication
- Comes with rice spoon & measuring cup
- With three preset cooking programs for rice, soup, and congee
- With buttons    for manual time adjustment



CE

Code	Model	Power supply	Power Kw	Χωτηρικότητα	Weight Kg	Dimensions (L*W*H)mm	Price
300.0760	RC-16L	230V/50Hz	2.25	16L	2.25	470*420*370	240€

Soup tureen

The chafing dish is designed to keep food warm, using liquid heat from a bain-marie to gently heat food without burning or drying it out.

 *Ideal for hotels, restaurants, catering, and outdoor gatherings.*



CE

Code	Model	Power supply	Power	Λίτρα	Diameter	Price
300.0625	SK-10	230V/50Hz	400W	10L	360*400	100 €

Waffle maker

- Made of stainless steel
- Non-stick plates
- Temperature range: 50-300°C
- Rotary feature for even baking



Ideal for cafes, bakeries, bars, and hotels.



Code	Model	Power	Power	Cooking surface mm	Weight Kg	Dimensions (L*W*H) mm	Price
300.0020	WFR-1	230V/50Hz	1.35	ø190	12	435*255*300	350€

Waffle iron

- Non-stick removable plates
- Made of stainless steel
- Temperature range: 50-300°C
- Rotary feature for even baking
- Ideal for cafes, bakeries, bars & hotels



Code	Model	Power	Power Kw	Cooking surface mm	Dimensions (L*W*H) mm	Price
300.0022	WFR-1S	230V/50Hz	1.6	ø190	250*450*300	220€
300.0023	WFR-2S	230V/50Hz	2.6	ø197	500*540*315	380€

RWM-1350 for waffles

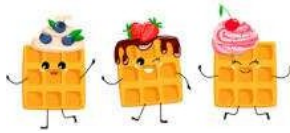

- Made of stainless steel
- Non-stick plates
- Temperature range: 50-300°C
- Rotary feature for even cooking



Ideal for cafes, bakeries, bars, and hotels.



CE

Code	Model Power	Power supply	Power Kw	Cooking surface mm	Weigh t Kg	Dimensions (L*W*H) mm	Price
300.0699	RWM-1350	230V/50Hz	1.30	ø197	8.5	540*250*315	350€

Burger device

- Non-stick plates for burger
- With 90° plate opening
- Made of stainless steel
- Temperature range: 50-300°C
- Uniform cooking (rotary)
- Ideal for cafes, bakeries, bars, and hotels



Scan here



CE

Code	Model	Power	Power	Cooking surface mm	Dimensions (L*W*H) mm	Price
300.0024	UFO WF-1RHS	230V/50Hz	1.30	Internal ø125 External ø195	540*250*315	270€

Ice cream funnel device

- Non-stick plates
- Temperature range: 50-300°C
- With 90° plate opening
- Green light indicates that it is on
- Orange light indicates preheating
- Ideal for cafes, bakeries, bars, and hotels

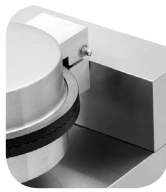

Code	Model	Power supply	Power Kw	Capacity/L	Dimensions (L*W*H)mm	Price
300.0021	CB-1	230V/50Hz	1.00	1	255*380*270	185€

Chocolate Dispenser

- Designed with a tap for easy use.
- Transparent 5L polycarbonate jug
- Removable stirrer for easy cleaning
- With on-off switch
- Temperature range 30°-90°C



Code	Model	Power supply	Power	Weight	Dimensions (L*W*H)mm	Price
303.0601	ΣΟΚΟΛΑΤΙΕΡΑ 5L BLACK	220V/50Hz	1006W	7.3	410*280*465	450€
303.0602	ΣΟΚΟΛΑΤΙΕΡΑ 5L RED	220V/50Hz	1006W	7.3	410*280*465	450€

Soft ice cream maker

Enjoy the experience of frozen drinks with Dynamic's modern ice cream maker, which transforms simple ingredients into delicious frozen drinks in just a few minutes.

With a 3-liter capacity, it is ideal for cafes, beach bars, and hotels. The built-in high-performance compressor freezes drinks without the need for ice, ensuring a uniform texture and consistent results every time.

The **digital display and 6 preset programs** make it easy to choose between granitas, frozen juices, smoothies, milkshakes, or frozen cocktails.

The quiet motor and precise temperature control offer reliable operation, even with frequent use.

The Dynamic ice cream maker also stands out for its ease of cleaning, thanks to its self-cleaning function, while the materials used in its construction are food-grade and certified according to international safety standards.

Ideal for:

- Soft ice cream • Granitas • Frozen juices
- Frappés • Smoothies • Milkshakes
- Frozen cocktails (low alcohol)



	HSC3L - GREY	HSC3L - WHITE
Code	300.085	300.0851
Power	230/50Hz	230/50Hz
Power	260W	260W
Coolant	R290	R290
Dimensions mm	204*417*455	204*417*455
Weight	12Kg	12Kg
Price	600€	600€

Crepe maker

- Non-stick heating plate with Teflon coating
- Stainless steel construction for easy cleaning and durability
- Built-in control system for maintaining a constant temperature
- Rotary temperature controls from 50-300°C.
- Removable stainless steel tray for crumbs.
- Ideal for cafes, bakeries, bars, and hotels



EC-2



EC-1N



EC-1



Code	Model	Power	Power Kw	Disc diameter mm	Weight Kg	Dimensions (L*W*H) mm	Price
300.0030	EC-1 Single	230V/50Hz	3	400	2	450*490*225	320€
300.0032	EC-1N Single	230V/50Hz	3	400	12.2	400*400*176	280€
300.0031	EC-2 Double	230V/50Hz	3+3	400+400	47	890*490*225	600€



Heated surface for buffet

- Stainless steel construction
- With two On-Off switches
- Temperature control via thermostat switch
- With stainless steel or ceramic surface
- Temperature range: 35-95°C
- Suitable for GN, plates, trays



Ceramic surface



Stainless steel surface



Stainless steel surface



Code	Model	Power	Power	Temperature range	Dimensions (L*W*H)mm	Price
303.0003	SHT-250	230V/50Hz	250W	30°-95°C	500*400*70	220€
303.0004	SHT-600	230V/50Hz	600	30°-95°C	1000*525*70	360€
303.0005	SHT-260	230V/50Hz	260W	30°-95°C	565*380*75	260€

Fat collector

- Top inlet 1 hole
- Three stages of filtration
- 1 oil separator
- 1 flow cap



Code	Model	Capacity	Dimensions L*W*H(mm)	Prices
300.3903	OF-350	25L	350*250*230	90€
300.3904	OF-500	40L	500*280*280	120€
300.3905	OF-550	60L	550*330*330	150€

Cup warmer

The professional cup warmer is an essential device for any café, restaurant, or office where hot beverages are regularly served. This cup warmer is designed to keep multiple cups or mugs at the perfect temperature for serving hot beverages such as coffee, tea, or hot chocolate. Operating temperature 75°C.



Code	Model	Power	Power	Weight	Dimensions (L*W*H)mm	Price
300.0795	MCW-2	230V/50Hz	140W	11.5	360*320*550	240€



Dish warmers

The professional wheeled plate warmer is a smart product designed to keep plates warm. It uses advanced heating technology to quickly heat dishes to the ideal temperature, ensuring that food remains hot when served. Ideal for restaurants and hotels.

- With On/Off switch
- Temperature adjustment via switch - thermostat
- Temperature range: 30-85°C



Code	Model	Power	Power	Weight	Dimensions (L*W*H)mm	Price
300.0790	PW-60 (Wheeled)	220V/50Hz	600W	20.2	390*290*545	460€
300.0791	PW-101 (Wheeled)	220V/50Hz	400W	31	450*550*870	740€
300.0792	PW-102 (Wheeled)	220V/50Hz	800W	48	450*910*930	1200€
300.0793	PW-120 (Wheeled)	220V/50Hz	1200W		600*560*770	560€

Isothermal container for beverages/soft drinks/food

- Made entirely of steel
- Double walls with thermal insulation
- With silicone gasket on the lid & vent valve
- Side handles for easy transport
- With rubber non-slip base
- Keeps cold for 4-6 hours
- Keeps hot for 6-8 hours



-Rubber gasket



-Foaming insulation



-Steam outlet



-Handle and button

Code	Model	Capacity	Dimensions (ø*H)mm	Price
303.0400	Isothermal container with bottom	4L	ø200*H160	170€
303.0401	Insulated container with base	8L	ø200*H280	190€
303.0402	Insulated container with base	10L	ø200*H170	200€
303.0403	Isothermal container with bottom	15L	ø200*H230	220€
303.0405	Isothermal container with bottom	20L	ø200*H310	230€



Isothermal containers



303.0701



GN 1/1*65mm x 6 pcs



GN 1/1*100mm x 4 pcs



GN 1/1*150mm x 3 pcs



GN 1/1*200mm x 2 pcs

303.0701

Dimensions	GN
1/1 x 6.5cm	6
1/1 x 10cm	4
1/1 x 15cm	3
1/1 x 20cm	2

303.0702 /303.0703

Dimensions	GN
1/1 x 6.5cm	8
1/1 x 10cm	5
1/1 x 15cm	4
1/1 x 20cm	3



303.0703



Code	Dimension	Storage	Liters	Dimensions	Price
303.0701	THERMAL CHAMBER	8-10 hours	90	650*450*635	300€
303.0702	THERMAL CHAMBER	8-10 hours	120	670*470*780	400€
303.0703	HEAT CHAMBER 350W	8-10 hours	120	670*470*780	940€



Wheeled heating chamber

- Stainless steel construction (201)
- Humidity function in the chamber
- Temperature control 30°- 85°C with special insulation and ability to maintain temperature at 60°C in case of power failure.
- 90° door opening
- Easy GN insertion and removal
- Protective corner rubber seals in the chamber.

**Price does not include GN and racks.*



Ideal for catering events, buffets, and other catering service environments where food needs to be kept warm for long periods of time.



Model	Model	Power	Power	Shelves	Weight Kg	Dimensions (L*W*H) mm	Price
300.3900	FW-5SA	230V/50Hz	1.3Kw	5GN 2/1	90	730*940*1350	1400€
300.3901	FW-11S	230V/50Hz	2.62Kw	11GN 2/1 10GN 1/1	133	730*940*1820	1700€
300.3902	FW-22S	230V/50Hz	2.62Kw	22GN 2/1 22GN 1/1 44GN 1/1	135	1540*940*1820	3000€

Food heating lamps



Black Cylindrical



Black Conical



Bronze Cylindrical



Gold Cylindrical



Bronze Conical



* Adjustable length belt



Code	Model	Lamp design	Color	Power	Power	Diameter	Weight	Price
300.7003	FWL-HL-C	Conical	Black	230V/50Hz	275W	270	1.5 kg	90€
300.7004	FWL-HL-E	Cylindrical	Black	230V/50Hz	275W	290	1.5 kg	90€
300.7005	FWL-HLE-B	Cylindrical	gold	230V/50Hz	275W	175	1.5 kg	90€
300.7006	FWL-HLE-C	Conical	bronze	230V/50Hz	275W	270	1.5 Kg	90€
300.7007	FWL-HLE-D	Cylindrical	gold	230V/50Hz	275W	290	1.5 kg	90€
300.7008	FWL-HLE-E	Cylindrical	bronze	230V/50Hz	275W	290	1.5 kg	90€

Height-adjustable heating lamp

- With adjustable height 600-1500mm
- Made of heat-resistant material
- Available in various colors, it complements the aesthetics of any space.



Pink gold
Cylindrical

Black
Cylindrical

Chrome
Cylindrical

Gold
Cylindrical



Code	Model	Power	Color	Dimensions mm	Price
303.0200	DYN-LAM-29B	275W	Black	ø290*H600-1500	80€
303.0201	DYN-LAM-29G	275W	Gold	ø290*H600-1500	80€
303.0202	DYN-LAM-29C	275W	Chrome	ø290*H600-1500	80€
303.0203	DYN-LAM-29RG	275W	Pink gold	ø290*H600-1500	80€
303.0204	DYN-LAM-175B	275W	Black	ø175*H600-1500	80€
303.0205	DYN-LAM-175G	275W	Gold	ø175*H600-1500	80€
303.0206	DYN-LAM-175C	275W	Chrome	ø175*H600-1500	80€
303.0207	DYN-LAM-175RG	275W	Pink gold	ø175*H600-1500	80€

Microwave Ovens



AG9

25-liter microwave oven with digital control

- Digital LED display
- 900W microwave power
- With power adjustment
- Child lock function
- With 1000W grill function
- Defrost program with time/weight
- Preset automatic programs
- With rotating glass bottom



Child Lock Function



Defrost By Weight/
Time



Preset Auto Menus



AM025F4R-S0SE00

- Stainless steel front
- Digital LED display
- Rotary switch for time selection
- Defrost program
- With 5 levels for power selection
- Plate diameter up to 30.5 cm



Defrost



Model	Model	Power	Power	Liters	Weight Kg	Dimensions (W*D*H) mm	Price
300.0759	AG9	230V/50Hz	900W	25L	12.43	469*280*377	170€
300.0749	AM025F4R DEFROST	230V/50Hz	1000W	25L	14.7	511*432*311	500€

Analog Microwave Oven

- Stainless steel construction
- Easy control with 6-minute timer and menu guide
- 1 power level & 1 cooking level
- Plate diameter up to 30.5 cm

Cheeseburger

Recommended Power: 1000W
A 9 oz. cheeseburger can be reheated in 1 minute



Sandwich

Recommended power: 1000W
8 oz. sandwich can be reheated in 1 minute



Analogue control



Digital Microwave Oven

- Stainless steel construction
- 5 power levels & 3 cooking levels
- 100 automatic programs
- LED display with end-of-cycle audible signal
- Time input x2 for multiple quantities
- Removable, cleanable air filter
- Plate diameter up to 35.6 cm

Ravioli

Recommended Power: 1400W
6 oz. ravioli can be reheated in 1 minute



Chicken with pilaf

Recommended power: 1400W
4 oz. of chicken with pilaf can be reheated in 20 seconds



Touch control



Code	Model	Power supply	Power	Power levels	Litra	Weight Kg	Dimensions (W*D*H)mm	Price
300.0770	AM025FJT-S0SE Analog	230V/50Hz	Output 1000W	1	25Lt	14,7	511*432*311	500€
300.0771	EMD34N Digital	230V/50Hz	Output 1400W	5	34Lt	20	553*485*343	700€

Oven cycle thermic

Commercial ovens designed for easy maintenance and even cooking. They use hot air evenly around the heating chamber to cook food.

Features

- **Partition in the fans for even distribution of hot air.**
- Stainless steel construction for longer life
- Non-slip rubber feet prevent sliding
- **Includes 4 trays and built-in lighting**
- Heat dissipation to extend the life of the machine
- Internal oven coating entirely in stainless steel
- Double-layer crystal-clear glass with high-strength insulation for optimal thermal performance.
- **With two motors**



Gap between pans 70 mm



Ideal for hotels, restaurants, cafes, and any professional catering establishment



Προβολή	Λειτουργίες
	Temperature Control
	Time Setting



Code	Model	Power supply	Power Kw	Dimensions chamber mm	Dimensions baking pan	Dimensions (L*W*H)mm	Price
300.0650	CO-4F	230V/50Hz	3.2	450*350*360	430*340mm	600*540*550	720€

Oven cycle-thermic

Professional ovens designed for easy maintenance and even baking. They use hot air evenly around the heating chamber.

Features

- **Partition in the fans for even distribution of hot air.**
- Stainless steel construction for longer life
- Non-slip rubber feet prevent sliding
- **Includes 4 trays and built-in lighting**
- Heat dissipation to extend the life of the machine
- Internal oven coating entirely in stainless steel
- Double-layer crystal-clear glass with high-strength insulation for optimal thermal performance.
- The oven has a water inlet design and a spray function, which helps with the fermentation of food
- **With two motors**

 *Ideal for hotels, restaurants, cafes, and any professional catering establishment.*



View	Functions
	Temperature Setting
	Grill setting
	Time Setting
	Water Spray Button



Code	Model	Power supply	Power Kw	Dimensions chamber mm	Dimensions baking pan	Dimensions (L*W*H)mm	Price
300.0654	CO-8F	380V/50Hz	5.0	700*360*460	600*400mm	834*710*572	1.200€

Oven cycle-thermic for bakery & confectionery

Commercial ovens designed for easy maintenance and even cooking. They use hot air evenly around the heating chamber to cook food.





Features

- U-shaped heating tubes provide rapid heating
- **REVERSE FAN FUNCTION**
- Stainless steel construction for longer life
- Non-slip rubber feet prevent sliding
- **Includes 4 trays and built-in lighting**
- Heat dissipation to extend the life of the machine
- Interior oven coating entirely in stainless steel
- Double-layer crystal-clear glass with high-strength insulation for optimal thermal performance.
- The oven has a water inlet design with a spray function, which helps with the fermentation of food
- **With a motor**

 *Ideal for hotels, restaurants, cafes, and any professional catering establishment.*



10 cm gap between baking trays

View	Functions
	Temperature Setting
	Time Setting
	Water Spray Button
	Left Switch ► Lighting Function On/Off Right Switch ► Allows the oven to operate without the timer. (In the Off position)

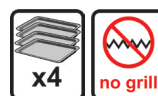

Code	Model	Power supply	Power Kw	Dimensions chamber mm	Dimensions baking pan	Dimensions (L*W*H)mm	Price
300.0651	EC01-E	380V/50Hz	6	620*422*448	600*400mm	920*760*600	1.350 €

Oven cycle thermic

Commercial ovens designed for easy maintenance and even cooking. They use hot air evenly around the heating chamber to cook food.

Features

- **With LCD display for temperature and time**
- With electronic lock
- Three-stage automatic cooking
- Built-in water tank
- **With 9 programmable memories**
- Air speed adjustment (low, medium, high)
- Heating with two-way air circulation
- **Includes 5 baking trays**



1. Spraying functions,
2. Drying,
3. Heat retention,
4. Cooling,
5. Stove function
6. Lighting
7. Three-stage baking

Ideal for hotels, restaurants, cafes, and any professional catering establishment



Gap between pans 9cm

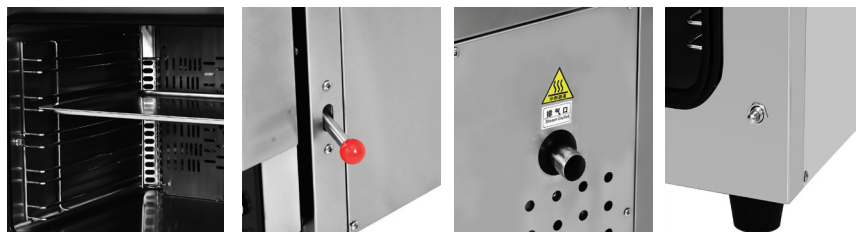

Code	Model	Power supply	Power Kw	Dimensions chamber mm	Dimensions baking pan	Dimensions (L*W*H)mm	Price
300.0656	CK06-120L	380V/50Hz	6.0	663*469*481	600*400mm	840*849*789	1.600€

Food dehydrator

A food dehydrator is a device for drying fruit, vegetables, mushrooms, and herbs at temperatures ranging from 30°C to 90°C. During drying, the water/moisture contained in the food is removed and the food is dehydrated. The nutrients in fruit or vegetables are preserved if stored correctly in airtight glass jars. You can create beautiful and healthy snacks such as fruit (pears, plums, apricots, bananas, etc.), raisins, dried vegetables for soups, dried tomatoes, dried herbs, herbal teas (mint, chamomile, etc.), dried mushrooms for soups and meals, dried oranges for decoration, dried pumpkin seeds, etc.



- SUS304 stainless steel construction
- Digital control touch screen panel
- Door handle can be plastic or aluminum
- FD6: Number of shelves: 6
(upper and lower shelf spacing: 43 mm)
- FD12: Number of trays: 12
(upper and lower shelf spacing: 30 mm)
- With removable trays and additional crumb tray
- Time: 0-24 hours adjustable
- Temperature adjustment range: 30~90°C
- Operating noise: 45-50 decibels

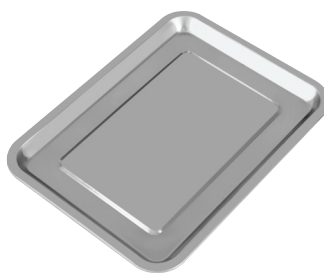
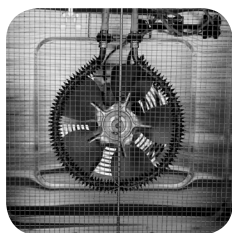

Code	Model	Power supply	Power	Drying tray size	Shelves	Dimensions (L*W*H)mm	Price
300.0665	FD-6	230V/50Hz	400W	280*200mm	6	356*300*355	340€
300.0666	FD-12	230V/50Hz	1000W	390*283mm	12	462*402*447	420€

Heated sauce & cheese dispenser

Electric tabletop heated round dispenser ideal for chocolate, caramel syrup, thick sauces & cheddar sauce for nachos.

With 6 temperature settings

1. 35
2. 51
3. 63
4. 74
5. 85
6. 99°C



	CW-4.4A
Code	300.0620
Power supply	230/50Hz
Power	500W
Capacity	4.4L
Distributor diameter	8
Dimensions	230*420*380
Weight	2.89 kg
Price	€475



Ideal for hotels, cinemas, theaters, supermarkets.



Heated nachos display case

- Stainless steel construction
- With LED lighting
- Operating temperature 55°C
- With On/Off switch
- With residue collection container
- Includes nachos basket
- With non-slip feet



	FFI-330
Code	300.0016
Power	230/50Hz
Power	105W
Dimensions	400*325*625
Weight	10kg
Price	280€



Hot Dog heater

- Entirely stainless steel construction
- Fireproof glass container with a capacity of up to 40 sausages
- Temperature control via thermostat switch
- With On-Off switch
- Temperature range: 30-100°C
- With side handles



Code	Model	Power	Power	Weight	Dimensions (L*W*H)mm	Price
300.0660	HDW-1	230V/50Hz	450W	5.4kg	288*260*405	220€

Hot Dog heater

- SUS 201 stainless steel construction
- With On-Off switch
- Temperature control via thermostat switch
- High capacity: up to 50 buns & 200 sausages
- With stainless steel water tank capacity 7.8L
- With sliding doors
- With drain tap
- Temperature range: 30-110°C



Code	Model	Power	Power	Weight	Dimensions (L*W*H)mm	Price
300.0674	HDS-2	230V/50Hz	2Kw	11.8kg	345*405*645	260€

Hot Dog warmer/Bread warmer

- Stainless steel construction
- With 4 bread heating rods
- Temperature range: 50-300°C
- With two On-Off switches (separate for the rods and the glass)
- Heat-resistant glass jar
- Temperature control via thermostat switch



Code	Model	Power	Power	Dimensions (L*W*H)mm	Price
303.0002	HHD-04	220V/50Hz	700	467*300*386	260€

Hot Dog Grill

- Stainless steel construction
- With On-Off switch
- Temperature control via thermostat switch
- With two independent heating zones



With glass cover



Code	Model	Cylinders	Power	Power	Dimensions (L*W*H)mm	Price
303.0001	HHD-07	7	220V/50Hz	1765W	580*330*515	280€
303.0000	HHD-09	9	220V/50Hz	2200W	580*430*515	260€

Popcorn Machine on Wheels

- Non-stick plate resistant to high temperatures, with constant temperature to keep popcorn fresh and crispy
- Fast heating
- Stainless steel interior
- Aluminum exterior
- The door is made of polycarbonate
- Non-slip feet prevent slipping
- **Maximum output of 147 portions/hour**

	PC-803
Code	300.0658
Power	1400W
Power	220V/50Hz
Capacity	40L
Dimensions (W*D*H)	920*370*1530mm
Weight	15
Price	460€



Popcorn machine

- Stainless steel exterior
- Aluminum interior
- Door made of durable glass
- **Maximum output of 150 servings/hour**
- Color: red



	PC-802
Code	300.0655
Power	1450W
Power	220V/50Hz
Dimensions (L*W*H)	555*420*740mm
Weight	14.86Kg
Price	240€



CE

CE

Dough molding machine

- Stainless steel construction
- Resin cylinder suitable for food
- Transparent cover for monitoring operation



Dough thickness 0.7 mm-5.4 mm



	PM-30	PM-40
Code	300.0764	300.0765
Power	230/50Hz	230/50Hz
Power	370W	390W
Dough thickness	0.7-5.4 mm	0.7-5.4 mm
Dough diameter	100~300 mm	100~400 mm
Short cylinder	φ25*φ48*300mm	φ48*φ25*216mm
Long cylinder	φ48*φ25*422mm	φ50*φ20*348mm
Dimensions mm	340*505*700	370*565*715
Weight	35	42
Price	1000€	1100€



BPD-40 Horizontal dough molding machine

- Stainless steel construction
- Equipped with food-grade resin roller
- Flat entrance
- Controlled by foot switch
- Overheating protection
- With transparent cover for monitoring operation
- Can be mounted on a workbench or wall



	BPD-40
Code	300.0768
Power	230/50Hz
Power	450W
Dough thickness	0.7-5.4 mm
Dough weight	50~500
Dough diameter	100-400 mm
Dimensions	544*363*346
Weight	28
Price	€700

Pizza ovens

EP-1ST single stone



Code 300.0026

Electric pizza oven Power supply: 230V/50Hz **Power:** 2Kw
Plate dimensions: 400*400
 With stone interior
Dimensions: 560*570*280mm
Temperature: 0-350°C **Price:** €240



EP-2ST double stone



Code 300.0027

Electric pizza oven Power supply: 230V/50Hz **Power:** 3Kw
Plate dimensions: 400*400
 With stone interior
Dimensions: 560*570*440mm
Temperature: 0-350°C **Price:** €360

EP-235M double stone pizza oven

- With separate heating elements above and below each chamber for maximum heat and balanced baking results.
- Separate temperature control for each heating element in each chamber (2 top, 2 bottom) and 2 separate timers.
- With separate switches for interior lighting and power supply.
- High-strength glass windows for monitoring the progress of baking.

Code 300.0018

Electric pizza oven Power supply: 230V/50Hz **Power:** 4Kw
Plate dimensions: 400*400
 With stone interior
Dimensions: 620×600×525mm
Temperature: 0-350°C **Price:** €500



Induction hobs

- Flat surface
- Black glass surface
- Overheating protection
- LED display
- Entirely stainless steel
- Sturdy construction
- 1m-24/h timer
- Temperature & power adjustment settings



Digital panel



GR-A100



GR-A200



GR-A300



PHOENIX



Ideal for restaurants, taverns, fast food outlets, hotels

Code	Model	Power supply	Range Power	Temperature range	Surface for baking	Dimensions mm	Price
300.3000	PHO-GR-A100	230V/50Hz	400W-3500/1PH	80°C-240°C	ø28	350*450*140	380€
300.3010	PHO-GR-A200	380V/50Hz	550W-5000W/3PH	50°C-160°C	ø30	400*450*280	1200€
300.3020	PHO-GR-A300	380V/50Hz	2*400W-3500/3PH	80°C-240°C	ø30	400*700*200	1100€

Induction hobs

Economy series



- Flat surface
- Black glass surface, 4 mm thick
- 32cm coil
- Overheating protection
- Timer: 240 min



IC-50A



IC-32C



IC-35A



IC-32C-2A



Code	Model	Power	Range Power	Temperature range	Cooking surface	Dimensions mm	Price
300.3100	IC-32C	230V/50Hz	200-3500W	70°C-280°C	ø32	455*530*150	280€
300.3102	IC-32C-2A	230V/50Hz	200-3500W*2	70°C-280°C	ø32*2	455*1000*150	600€
300.0028	IC-35A	230V/50Hz	200W-3500/1PH	70°C-280°C	ø28	350*450*145	220€
300.0029	IC-50A	380V/50Hz	5000/3PH	70°C-280°C	ø28	400*500*200	500€

Induction hobs

Economy series

- Flat surface
- 4 mm thick black glass surface
- Overheating protection
- Timer: 1 min-4 h



CM1Y



K1-2



Code	Model	Power supply	Range Power	Temperature range	Cooking surface	Dimensions mm	Price
300.0038	CM1Y	230V/50Hz	500W-3500W	60°C-240°C	ø28	350*430*120	300€
300.0039	K1-2	230V/50Hz	3500W*2	70°C-280°C	ø28*2	400*800*150	850€

IB-270TV Mixer Hand

- Ergonomic handle for the user
- Made of high-quality materials
- Stainless steel blades and bell for contact with food
- Comfortable to use and easy to assemble after cleaning
- With thermally adjustable overload protection button (VV) overload
- Professional use for ice cream shops, pastry shops, restaurants, and hotels
- For soups, sauces, fruit & vegetable purees

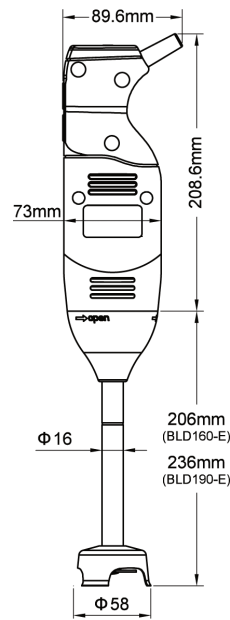

Code	Model	Power	Power supply	Axial	Price
300.0124	IB-270TV comple	270W	230V/50Hz	160mm	220€
300.0123	IB-250EV comple	250W	230V/50Hz	190mm	190€

650VV κομπλέ Μίξερ Hand

- Stainless steel motor cover
- Ventilated motor made in Italy
- Thermal overload protection included
- Ergonomic handle for comfortable use
- Digital liquid crystal display
- 9-speed regulator
- Fully detachable stainless steel shafts
- Pipe screw accessory
- Control board equipped with SRS device (self-regulating speed) for power and speed stabilization



Code	Model	Power supply	Power	Rotations knife	Dimensions A*Bmm	Price
061.0020	650VV complete with 400mm shaft & whisk	220V/50Hz	0,65Hp	2000/9000 max 13000	Aø130*B400	1100€

VORTEX 75VT Mixer Hand with head

- Effective cooling system
- Powerful and lightweight
- Ergonomic handle
- Rubber isolator between motor and shaft
- High-performance motor
- Protection button for activation
- Continuous operation switch
- IPX3 protection
- Quick assembly
- Made of stainless steel
- Easy disassembly of shafts for proper cleaning, ensuring long service life
- Ideal for bakeries, restaurants, catering
- **Ideal for making whipped cream, desserts, cream, mayonnaise, sauces**

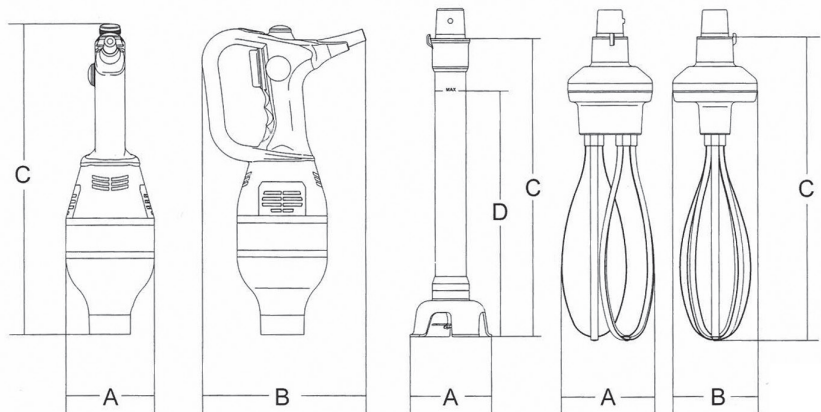

Code	Model	Power supply	Power	Rotations knife	Rotations wire	Liters/hour	Dimensions mm	Price
020.0600	Vortex 75VT	220V/50Hz	750W 1,00Hp	0÷13000	400÷1800	300lt	A125*B190*C390	640€

Code	Model	Weight	Dimensions (L*W*H)mm	Price
020.0602	Barra 350mm	1,2Kg	A100*C415*D350	360€
020.0603	Barra 450mm	1,6Kg	A100*C515*D450	370€
020.0605	Wire	1,2Kg	A117*B113*C385	390€



450VV | Moter Mixer Hand

- Stainless steel motor cover
- Ventilated motor made in Italy
- Thermal overload protection included
- Ergonomic handle for comfortable use
- 9-speed regulator
- Pipe screw accessory
- Control board equipped with SRS device (self-adjusting speed) for power and speed stabilization



Digital liquid crystal display



SRS Self-Regulating Speed

La tecnologia SRS consente di ottenere composti estremamente omogenei.
SRS device grants high-quality homogeneous mixtures.



Code	Moter	Power	Power supply	Rotations	Dimensions mm	Weight	Price
061.0021	450VV	0,45Hp	220V/50Hz	2000/11000 max 17000	Aø130*B380	-	550€

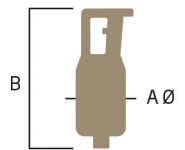

Code	Wire	Capacity	Weight	Price
061.0024	Fama Whisk	80L	-	260 €



Code	Axle	Capacity	Dimensions (H*B)	Weight	Price
061.0022	Axle 400mm	30/120Lt	B430*A95mm	1,0Kg	220€
061.0023	Axle 500mm	30/230Lt	B530*A95mm	1,6Kg	240€
061.0025	Axle 600mm	30/330Lt	B630*A95mm	1,2Kg	260€

IB500LV moter

- Ergonomic handle for the user
- Made of high-quality materials
- Stainless steel blades and bell for contact with food
- Comfortable to use and easy to assemble after cleaning
- With thermally adjustable overload protection button (VV)
- For soups, sauces, fruit & vegetable purees
- Professional use for ice cream shops, pastry shops, restaurants, and hotels



Code	Μότερ	Power	Power supply	Rotations	Dimensions mm	Weight	Price
300.0100	IB500LV	500W	230V/50Hz	4000-16000	AØ359xBØ91	1,98Kg	290 €

BLD Axles



Code	Σωλήνας	Height	Dimensions	Παραγωγή	Weight	Price
300.0101	BLD300	300mm	Ø35mm	35Lt / ώρα	1.02Kg	130 €
300.0102	BLD400	400mm	Ø35mm	65Lt / ώρα	1.28Kg	145 €
300.0103	BLD500	500mm	Ø35mm	100Lt / ώρα	1.56Kg	155 €

*Sold with different stainless steel shafts and wire

WIK 250 wire



Code	Σύρμα	Height	Weight	Price
300.0105	WIK250	250mm	0,86Kg	150 €



MioMix Hand Blender

- Professional-grade machines
- Innovative plastic body design
- Lightweight with ergonomic handle for comfortable use
- Italian-made ventilated motor
- Includes thermal overload protection
- Speed regulator
- Electronic Speed and Power Stabilization System (SRS) (self-regulating-speed).



Available shafts in two sizes: 200-250mm



Code	Model	Capacity	Weight	Dimensions	Price
061.0028	Hand Mixer Motor 0.25Kw Light Blue	1/20Lt	0,45Kg	B270*A75mm	320€
061.0031	Hand Mixer Motor 0.25Kw Green	1/20Lt	0,45Kg	B270*A75mm	320€

MioMix Axle



Code	Αξονας	Capacity	Dimensions	Weight	Price
061.0029	Miomix Axle FM-200	1/15Lt	B220*A75mm	0,40Kg	110 €
061.0030	Miomix Axle FM-250	1/20Lt	B270*A75mm	0,45Kg	125 €

MioMix hand blender

- Professional use machines
- Plastic body with innovative design
- Lightweight with ergonomic handle for comfortable use
- Italian-made ventilated motor
- Includes thermal overload protection
- Speed regulator
- Electronic speed and power stabilization system SRS (self-regulating-speed).



Code	Model	Capacity	Weight	Dimensions	Price
061.0026	Hand Mixer Cassette 0.25Kw Beige	1/20Lt	0.45Kg	B270*A75mm	860€
061.0027	Hand Mixer Cassette 0.25Kw Green	1/20Lt	0.45Kg	B270*A75mm	860€

*Prices do not include VAT. Prices are subject to change without notice.
The company is not responsible for any typographical errors.*

Juicer low speed for fruits and vegetables

- Stainless steel construction
- High-performance motor
- Distillation cap
- Special feed chute for easy loading of pieces
- With two buckets: one for juice and one for waste
- Equipped with two accessories: knife/strainer
- Removable parts for easy cleaning
- Cleaning brush

Ideal for restaurants, cafes, bars, hotels

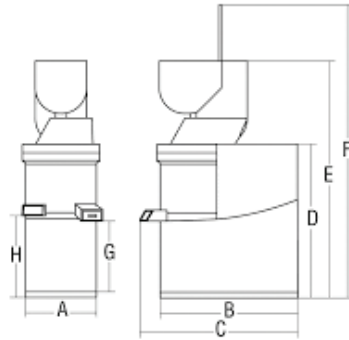

Dimensions:

A145*B220*C240*D342*E450*F530*G160*H166



SIRMAN

Code	Model	Power supply	Power	Rotations	Weight	Price
020.0620	Ektor 37	230V/50Hz	0,34Hp	37	6,7Kg	560€



Juicer SC-1591

- Made of stainless steel and plastic
- High-performance motor
- Distillation lid
- Special feed chute with special pusher
- With two buckets: one for juice and one for waste
- Equipped with two accessories: knife/strainer
- Removable parts for easy cleaning

Ideal for restaurants, cafes, bars, hotels



CE

Code	Model	Capacity κάδου	Power supply	Power	Dimensions	Price
300.0059	SC-1591	1000ml	230V/50Hz	550W	320*300*330	150€

Automatic Orange Juicer

The automatic orange juicer is the ideal solution for producing freshly squeezed orange juice. The automatic orange feeding system makes it fast and convenient, while its stainless steel construction with removable plastic parts makes it easy to clean. With a production capacity of 20 oranges/minute. It is suitable for restaurants, cafes, hotels, fast food restaurants, bars, and other catering establishments that offer a variety of juices.



MK-255E-1



MK-255E-1F



Code	Model	Power	Power	Weight	Dimensions (L*W*H)mm	Price
300.0753	MK-255E-1	230V/50Hz	120W	41	530*350*850mm	1150€
300.0754	MK-255E-1F	230V/50Hz	120W	41	530*350*850mm	1300€



SCAN HERE VIDEO



Lemon squeezer

- Cast aluminum construction
- High-performance motor
- Removable parts for easy cleaning

Ideal for restaurants, cafes, bars, hotels

CJ50MS

Includes 3 different cone sizes (φ80/φ60/φ40)



CJ50MH
with 1 cone



with heavy-duty lid



Code	Model	Speed/rpm	Power	Power	Dimensions	Price
300.0757	CJ50-MH	1500rpm	230V/50Hz	250W	200*398*330mm	380€
300.0758	CJ50-MS	1500rpm	230V/50Hz	250W	200*360*228mm	320€

Tomato machine

Can be used to chop tomatoes, fruit, and various vegetables. Features a push-action mechanism and built-in guards to protect hands and fingers.

- Stainless steel
- Durable design
- Easy to clean
- Easy to use
- Blade: serrated blade
- Non-slip feet
- Dimensions: 430 x 200 x 195 mm

Ideal for restaurants, cafes, home and commercial use.



	HT-5.5
Code	300.025
Blade thickness	5.5mm
Weight	5kg
Price	250€



Juice cooler

The Juice Cooler allows you to enjoy your juice cool, especially on hot summer days. The innovatively designed chilled beverage machine not only allows you to drink juice anytime, anywhere, but also keeps the juice fresh and cool.



JD12Lx1



JD12Lx2

- Coolant: R290
- Cooling system: Forced cooling
- Drink temperature: 2°-8°C



Code	Model	Power supply	Power	Capacity	Dimensions (L*W*H)mm	Weight	Price
300.0780	JD12Lx1	230V/50Hz	200W	12Lx1	235*430*670	15kg	550€
300.0781	JD12Lx2	230V/50Hz	300W	12Lx2	370*430*670	22Kg	650€

Coffee maker

The coffee maker includes 2 glass jugs

Temperature limiter: Cut-off at 105°C

Automatic reset at 97°C

- Stainless steel construction
- With two heating plates at the top and base
- On/off switch
- Brewing indicator
- Triple safety protection
- With 2.5L water tank



Code	Model	Power supply	Power	Capacity κavάταç	Dimensions mm	Price
300.0125	CFM-2086	230V/50Hz	1900W	1.8L	205×405×455	220€

Icebreaker

Ice crusher with excellent performance and long service life.

Ideal for restaurants, cafes, bars, hotels

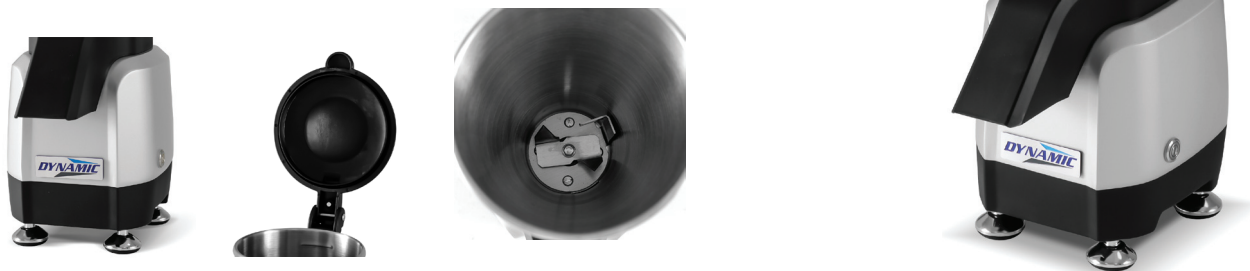

Code	Model	Speed	Capacity	Power supply	Power	Price
300.0667	IC-80A	1000rpm	3L	230V/50Hz	200W	500€

Frappé maker

- Plastic milkshake/frappé maker
- Sturdy base with legs for stability during use.
- Ideal for cafés, patisseries, bars, and hotels



CE

Code	Model	Power supply	Power	Capacity/L	Dimensions (L*W*H) mm	Price
300.0019	TM30A	220V/50Hz	380W	1000	195*190*530	150€



Stainless steel **water** boiler

- Interior, exterior, and base made of SS304 stainless steel
- Boiler thickness: 0.45 mm
- Heat-resistant ABS plastic handle
- Visual water meter and water tap
- On/Off switch with rubber cover
- With temperature regulator 30-100°C
- With level indicator
- VDE plug



BSCI, LFGB, ROHS, GS certification



Code	Model	Power	Power	Capacity/L	Dimensions	Price
300.0110	WB-8LD	230V/50Hz	1.5Kw	8	230*230*430	104€
300.0111	WB-10L-D	230V/50Hz	1.5Kw	10	230*230*500	112€
300.0112	WB-18L-D	230V/50Hz	2.0/2.5Kw	18	290*290*498	136€

Stainless steel coffee maker

- Interior, exterior, and base made of SS304 stainless steel
- Boiler thickness: 0.45 mm
- Heat-resistant ABS plastic handle
- Visual water meter and water tap
- On/Off switch with rubber cover
- With temperature regulator 30-100°C
- With level indicator
- VDE plug



BSCI, LFGB, ROHS, GS certification

Code	Model	Power	Power	Capacity	Dimensions	Price
300.0424	CB-8LD	230V/50Hz	950W	8L	220*420H	140€
300.0425	CB-10LD	230V/50Hz	950W	10L	220*472H	160€

Black water boiler

- Interior, exterior, and base made of SS304 stainless steel
- Boiler thickness: 0.45mm
- Heat-resistant ABS plastic handle
- Optical water meter and water tap
- On/Off switch with rubber cover
- With temperature control 30-100°C
- With level indicator
- VDE plug



BSCI, LFGB, ROHS, GS certification



Code	Model	Power	Power	Capacity/L	Dimensions	Price
300.0440	WB-8LAD-304	230V/50Hz	1.5Kw	8	230*230*430	160€
300.0441	WB-12LAD-304	230V/50Hz	1.5Kw	12	230*230*500	170€
300.0442	WB-16LAD-304	230V/50Hz	2.0/2.5Kw	18	290*290*498	170€

Black coffee maker

- Interior, exterior, and base made of SS304 stainless steel
- Boiler thickness: 0.45 mm
- Heat-resistant ABS plastic handle
- Visual water meter and water tap
- On/Off switch with rubber cover
- With temperature regulator 30-100°C
- With level indicator
- VDE plug



BSCI, LFGB, ROHS, GS certification

Code	Model	Power	Power	Capacity	Dimensions	Price
300.0443	CB-8LAD-304 black color	230V/50Hz	950W	8L	220*420H	160€
300.0444	CB-12LAD-304 black color	230V/50Hz	950W	12L		180€
300.0445	CB-16LAD-304 black color	230V/50Hz	950W	16L		180€

Cutter

BK-A30 | BK-A60 Meat Grinder



Large capacity and durability.

You can mince and grind various ingredients, such as meat and vegetables.

- With four (4) stainless steel blades
- With non-slip base
- Stainless steel bowl
- With two (2) speeds



BK-A30



BK-A60



Code	Model	Power	Power Hp	Capacity	Dimensions mm	Weight	Price
300.0800	BK-A30	230V/50Hz	400W	3L	200*200*310	1.5	80€
300.0801	BK-A60	230V/50Hz	1000W	6L	400*270*220	3Kg	100€

Cutter

Katana *Ideal for meat and vegetables*

- The blades are powered by a ventilated motor
- Stainless steel removable bowl
- With three cutting blades
- Safety lid
- Easy to clean
- Waterproof IP67 keypad
- Removable blades
- Waterproof motor protection



Ideal for restaurants, catering, and hotels



Katana 20VV

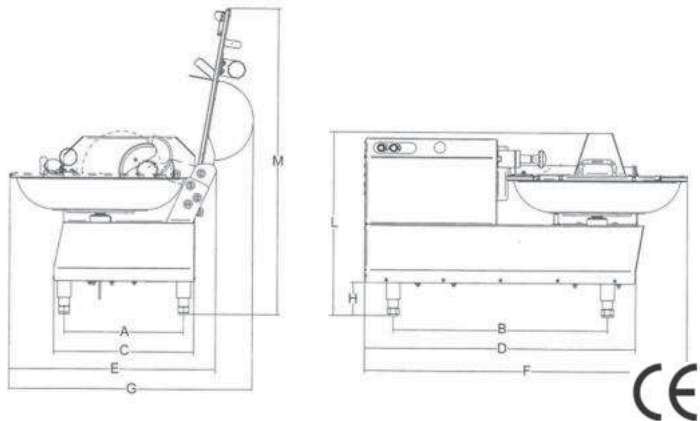

Code	Model	Basket capacity	RPM	Weight	Power	Power rating	Hp
020.0417	Katana 6	4.5 Kg	144	60	230V/50Hz	0.5	Then
020.0415	Katana 12	9.0	1440	75	230V/50Hz	1	Order
020.0416	Katana 20VV	15 kg	600/2,600	92 kg	230V/50Hz	3	8500

Dimensions mm	
Katana 6	A297 x B540 x C356 x D714 x E516 x F832 x G582 x H92 x L472 x M760
Katana 12	A335 x B600 x C393 x D758 x E587 x F902 x G680 x H92 x L508 x M850
Katana 20VV	A33590 x B650 x C450 x D820 x E700 x F1013 x G822 x H92 x L572 x M1010

Cutter

Blitz

- Polycarbonate lid with hole for adding food during pulping
- Motor and bucket base
- Temperature insulator
- Removable lid for easy cleaning
- Includes: Bucket with stainless steel blades, scoop

Cuts and grinds vegetables, meat, nuts



Ideal for restaurants & bakeries



Code	Model	Power	Power Hp	RPM	Capacity	Dimensions mm	Price
020.0410	Blitz	220V/50Hz	0.50	280	3.2L	240*240*330	1000€

C4/C6/C9

- Stainless steel AISI 304 construction with heavy-duty blades
- S/S bowl with handles and heavy bottom
- Motor with effective ventilation for continuous operation
- Safe operation thanks to micro switch system, etc.

Cuts and grinds vegetables, meat, nuts



Ideal for restaurants & pastry shops



C4 / C6



C9V
with speed control



Code	Model	Power	Power Hp	Capacity	RPM	Dimensions mm	Price
020.0411	C4	230V/50Hz	0.50	4L	280	160*310*305*365*255	1,300€
020.0413	C6 VV	230V/50Hz	0.50	6L	280	160*310*305*365*320	1,700€
020.0414	C9 VV	230V/50Hz	0.50	9L	280	225*410*355*455*380	2,500€

Cutter

HR

- Entirely stainless steel construction
- With stainless steel blades
- Removable bucket for easy cleaning and use
- **HR:** With speed control
- **LFC:** With speed selection



Ideal for restaurants, canteens, pizzerias, and food processing businesses



HR



LFC-18V2



Code	Model	Power	Power r Hp	Capacity	RPM	Dimensions (L*W*H)	Price
300.0222	HR - 6	220V /50Hz	1	6L	0-2200	450*300*350	660€
300.0223	HR - 9	220V /50Hz	1	9L	0-2200	470*330*400	720€
300.0225	LFC-18V2	220V /50Hz	3	18L	1500- 2200	495*455*795	1800€

MFP-3

- Plastic bin
- Stainless steel blades
- Plastic frame
- Removable bucket for easy cleaning
- Sturdy construction
- Two speeds



Ideal for cafes, bars, and snack bars



Code	Model	Power	Power	Capacity	RPM	Dimensions (L*W*H)	Price
300.0069	MFP-3	230V/50Hz	60	3L	150	-	600€

Blender *Can crush ice, mix, puree, and chop*

- Choice of 7 different programs

1. Juice
2. Smoothies
3. Ice crushing
4. Soups
5. Pureeing
6. Sauces
7. Manual operation

- Manual selection for increasing/decreasing speed and time via the rotary selector
- Stainless steel bowl and blades

Japan 6 points

- Easy to use and clean
- With pulse switch for cleaning
- Includes tamper for improved stirring and processing
- With transparent 2-liter BPA-free polycarbonate jug with measuring cup in ml/oz/cups

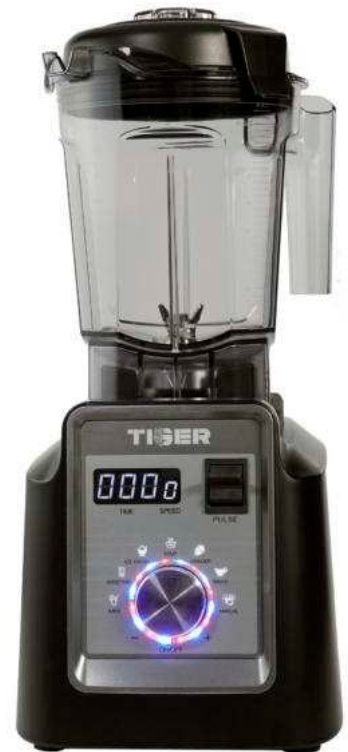

Ref.: 300.0803
Color: glossy black

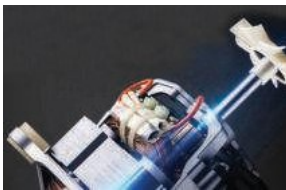

Powerful 2KW motor



Japan 6-point blades



With illuminated panel



Ref.: 300.0802
Color: glossy red



Ref.: 300.0804
color: matte silver

Available colors: black, red, silver



TIGER

GB-A100

Power	2000W
Capacity	2L
Dimensions (W*D*H)	196*228*444mm
Dimensions (L*W*H) with packaging	362*253*251mm
Weight with packaging	4.5Kg
Price	190€

One (1) year warranty on parts The warranty does not cover the jug

Blender *Can crush ice, mix, puree, and chop*

- Choice of 3 different programs via buttons with illuminated indicator
- 1. Ice crushing 2. Pureeing 3. Smoothies**
- Stainless steel bowl and blades
- Japan 6 points**
- With Min-Max speed control
- With power switch
- With 0-5m timer for time adjustment
- With transparent polycarbonate **2lt BPA-Free** jug
- With measuring cup in ml/oz/cups
- Easy to use and clean
- With Pulse switch for cleaning the blender
- Includes tamper for improved stirring and processing



Powerful 2KW motor



Japan 6-point blades



Item no.: 300.0806
Color: glossy black



Ref.: 300.0807
color: matte silver



Item no.: 300.0805
color: red



Panel

Available in colors: black, red, silver



One (1) year warranty on parts (The warranty does not cover the jug)

TIGER		GB-A200
Power		2000W
Capacity		2L
Dimensions (W*H*D)		196*228*444mm
Dimensions (L*W*H) with packaging		362*253*251mm
Weight with packaging		4.5Kg
Price		190€

Blender *Can crush ice, mix, puree, and chop*

- Choice of 6 different programs
 1. Juice
 2. Smoothies
 3. Ice crushing
 4. Soups
 5. Pureeing
 6. Manual operation with audible selection alert
- With transparent 2-liter BPA-free polycarbonate jug
 - With measuring cup in ml/oz/cups
- With Min-Max speed control
- **Quiet 72dB operation**
- Powerful heavy-duty motor, ventilated
- Stainless steel comb & **6-point Japan** knives
- With power switch
- Easy to use and clean
- With pulse switch for cleaning the blender
- Includes tamper for improved mixing and processing



Powerful 2KW motor



6-point Japan blades



Ref. no.: 300.0810
Color: glossy black



Ref.: 300.0808
Color: matte charcoal



Ref.:300.0809
Glossy red color



Panel

TIGER

	GB-A300
Power	2000W
Capacity	2L
Dimensions (W*D*H)	224*222*493mm
Dimensions (L*W*H) with packaging	295*280*570mm
Weight with packaging	7.7
Price	240€

Available in colors: black, red, charcoal



One (1) year warranty on parts (The warranty does not cover the jug)

Blender

- Choice of 6 different programs
 1. Juice
 2. Smoothies
 3. Ice crushing
 4. Soups
 5. Pureeing
 6. Sauces
 7. Manual operation
- With transparent 2-liter BPA-free polycarbonate jug with measuring cup in ml/oz/cups
- Manual option for increasing or decreasing speed or time via Touch Panel
- **Quiet 72dB operation**
- Powerful heavy-duty motor, ventilated
- Stainless steel **6-point Japan** blade assembly
- With Touch Power
- Easy to use and clean
- With Touch Pulse for cleaning the blender
- Includes tamper for improved stirring and processing



Color: matte charcoal



- ✓ Ice crushing
- ✓ Mixes
- ✓ Purees
- ✓ Crushes



Touch Panel



Powerful 2KW motor



Japan 6-point blades

TIGER

GB-A500

Code	300.0813
Power	2000W
Capacity	2L
Dimensions (L*W*H)	224*222*493mm
Dimensions (L*W*H) with packaging	295*280*570mm
Weight with packaging	7.7
Price	300€



One (1) year warranty on spare parts. (The warranty does not cover the jug)

Pastry Mixer

- With safety relay for user protection
- Made of special aluminum alloy
- Heavy-duty construction
- Motion is transmitted by metal gears
- With removable stainless steel bucket

The speeds (3) do not change during operation

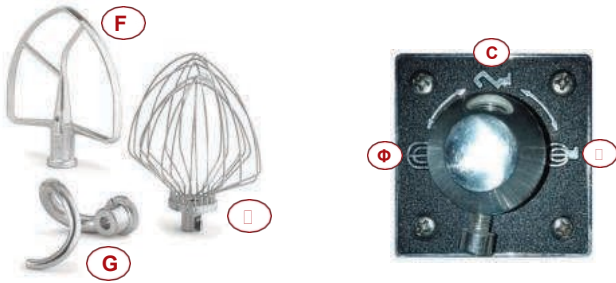

* Oza snktedat aş

Φ φρνίλλδ, C υίθτακ, □ stla



B10GFA



Code Model	Kw/HP/ Power supply	Max. Dough	⊘ Heigh t	Revoluti ons G/F/S	Dimensions (L*W*H)	Weight Kg	Price
300.0080 B10GFA	0.62/0.80/220-50Hz	4 2.5Kg	27 26	148/244/480	470*420*620	45	880€
300.0081 B20GA	1.10/1.50/220-50Hz	8 5.0	36 29	197/317/462	540*470*810	65	980€
300.0082 B30GA	1.50/2.00/220-50Hz	10 6.0	38 34	197/317/462	550*520*810	66	1240€



Pastry Mixer

- With safety relay for user protection
- Made of special aluminum alloy
- Heavy-duty construction
- The movement is transmitted by metal gears
- With removable stainless steel bucket

The speeds (3) do not change during operation

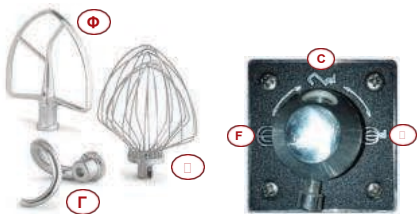

* Oza snthkettad as

ⓕ φρνίλλο, ⓓ ὄρθακ, ⓐ stela

Code Model	Kw/HP/ Power supply	kg Max. Dough	⊘ Heigh t	Revoluti ons G/F/S	Dimensions (L*W*H)	Weight Kg	Price €
300.0083 B40A	2.10/2.85/380-50Hz	12 8.0	40 38	120/187/520	640*620*1140	170	2260 €
300.0084 B60A	2.30/3.10/380-50Hz	25 15 kg	49 44	114/221/458	920*670*1630	363	4760€

Pastry Mixer

- With safety relay for operator protection
- Made of special aluminum alloy
- Motion transmission with belt and gears
- With stainless steel bucket
- With speed regulator
- Mixing cream: 1.5 kg



Ideal for restaurants, bakeries, and home use



MK-8602



1-3 SPEED
(KNEADING DOUGH)



4-6 SPEED
(BREAD ETC)



7-8 SPEED
(WHISK EGG WHITE, CREAM ETC)



CS-B10L

* Accessories included: whisk, dough hook, beater

Code	Model	Liters	Max. dough	Power supply / Power	Weight	Dimensions mm	Price
300.0070	CS-B5A	5.5	500	230V/50Hz/0.3Kw	14	350*230*400	560€
300.0071	CS-B7A	7.5	800	230V/50Hz/0.3Kw	16	400*250*410	680€
300.0072	CS-B10L	10	1	230V/50Hz/0.5Kw	17 kg	370*260*440	760€
300.0104	MK-8602	12	1	230V/50Hz/0.2Kw	8.9Kg	460*290*440	300€

Rapid fermenters

Bench-top mixer with large capacity to meet multiple needs for professional and home use. Easy food placement and replacement of additional equipment - accessories.

- Stainless steel bowl 201
- Available colors: white and black
- Suitable for bread, croissants, pizza

Ideal for pizzerias, bakeries, and restaurants



	HS-10L
Code	300.0094
Power	230/50Hz
Power	1.1Kw
Mixing capacity	5Kg
Flour capacity	10
Bowl capacity	15L
Mixing speed	100 r/min
Bowl speed	12 r/min
Dimensions	630*340*600
Weight	65kg
Price	1100€

Rapid fermenters

Stainless steel bucket and stainless steel agitators. Stable machine with low noise levels.

- Stainless steel bin
- With three wheels for easy movement
- With reverse function
- Suitable for bread, croissants, pizza



Reverse gear

HG30S



HG50S



SH20A



Ideal for pizzerias, bakeries, and restaurants



Code	Model	Power supply	Bucket	Capacity Mixture	Rotations/ Bucket rotation	Dimensions (L*W*H)	Weight Kg	Price
300.0091	SH20A	220V /1.5 Kw	23L	8 Kg	196/ 18	830*530*880	150	1700 €
300.0092	HG30S	380V/1.3-1.7Kw	28L	12.5Kg	230-150 / 23-15	850*430*940	167	1840 €
300.0093	HG50S	380V/2.8-3.6Kw	66L	25Kg	240-120 / 24-12	1030*580*1230	275	2600 €

Rapid fermenters

- Rapid fermenter
- Two speeds & safety stop button
- Stainless steel bucket and hook
- Rotating & removable bucket
- Opening head



Ideal for pizzerias, bakeries, and restaurants

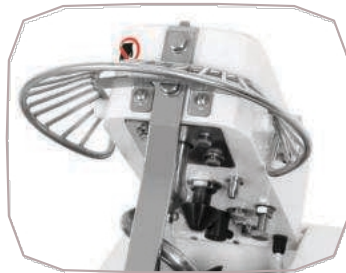

HSS10T



HSS30T



Code	Model	Kw/HP/ Power supply	Max. weight	Bucket capacity	RPM	Dimensions (L*W*H)	Weight Kg	Price
300.0096	HSS10T	0.55/0.74/230-50Hz	4	10L	135/90min	576*312*586	66	1260€
300.0097	HSS20T	1.1/1.47/230-50Hz	8	20L	135/90min	695*395*630	108	1600€
300.0098	HSS30T	1.5/2.00/230-50Hz	12	30L	135/90min	810*445*715	134	1720€

*Prices do not include VAT. Prices are subject to change without notice.
The company is not responsible for any typographical errors.*

Fast-acting yeast *Smart dough mixer with high-speed converter*



- Simple operation via digital panel
- 10 speeds (belt drive)
- Two programs with memory
- Two stirring speeds



- Variable frequency drive
- Low noise level
- Automatic control system



- Ergonomic hook
- High-quality mixing results



- Rotating bowl in both directions
- Non-removable bowl
- Reverse button for unblocking dough



- Designed for easier cleaning

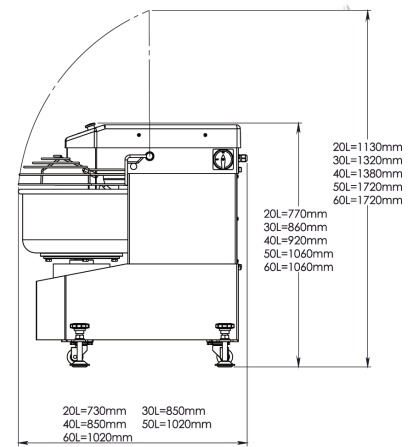
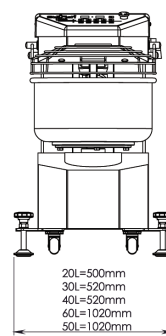
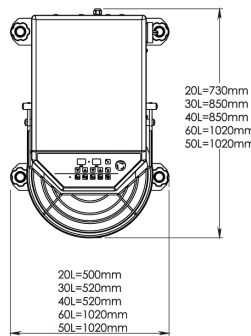

Code	Model	Kw/L/ Power Supply	Minimum dough	Max. dough	Speed basket rpm	Speed hook dough rpm	Dimensions (W*D*H)	Weight Kg	Price
300.0085	HX-40	2.6/45/220-50Hz	3Kg	20Kg	13-32	130-320	520*850*920	130	2200 €
300.0086	HX-50	3.3/55/380-50Hz	5Kg	25Kg	13-32	130-320	1020*1020*1060	170	2700 €
300.0087	HX-60	3.3/66/380-50Hz	6Kg	30Kg	13-32	130-320	1020*1020*1060	180	2900 €

PP Potato Cleaner

The PP series potato peeler can easily peel potatoes, carrots, and other vegetables and fruits, making your food processing more convenient.

Its stainless steel design makes it durable and easy to clean, ensuring hygienic and safe food processing. Peel quickly and efficiently, saving time and energy.

- Made of 201 stainless steel
- With timer on top & emergency stop
- Ergonomically designed door for easy operation
- Equipped with water supply and drainage
- Lid that allows the user to monitor the potato cleaning process.

Ideal for restaurants, food manufacturers, hotels.



Code	Model	Power supply	Capacity basket L	Power W	Pounds/ hour kg	Dimensions	Weight Kg	Price
300.0326	PP-6D	230V/50Hz	6	370	120-180	570*335*690	25	900€
300.0327	PP-10D	230V/50Hz	10	550	200-300	675*410*725	34	1050€

Potato Cleaner *Motion with a belt*

- Made of stainless steel
- Equipped with a microswitch that prevents the machine from operating when the lid or door is open
- Lid that allows the user to monitor the potato cleaning process.
- Adjustable metal feet that screw into the ground
- Equipped with water supply and drainage
- Reinforced air-cooled two-speed motor
- Automatic bucket emptying
- Potato cleaning disc
- Ideal for restaurants, food processing plants, hotels.



Code	Model	Power supply	Capacity basket L	Power W	Pounds/ hour kg	Rotations rpm	Weight Kg	Timer mm	Price
300.0256	HLP-15	230V/50Hz	20,6	750	165	320	58,40	0-5	1460€
300.0325	HLP-20	230V/50Hz	27	950	190	320	65	0-5	1600€

Potato peeler



- Made of AISI 304 stainless steel
- It has a microswitch that prevents the machine from operating when the lid or door is open.
- Transparent lid that allows the user to monitor the potato cleaning process.
- Adjustable metal feet that screw into the ground.
- Equipped with water supply and drainage
- Reinforced air-cooled two-speed motor
- Automatic bucket emptying
- Stainless steel potato cleaning tray
- Ideal for restaurants, food processing plants, hotels.

Belt drive (self-adjusting)



Code	Model	Power supply	Power Hp	Bucket capacity	RPM	Weight Kg	Dimensions (L*W*H) mm	Price
020.0750	PPJ 6SC	230V/50Hz	0.50	6Kg/10Lt	32	23	400*690*400	2,400€
020.0751	PPJ 10SC	230V/50Hz	1	10 kg/20 L	320	41.5	470*910*544	3,100€
020.0752	PPJ 10KG	380V/50Hz	1.5	10 kg/20 L	320	41.5	470*910*544	2,900€

Potato cutters



Electric

For cutting medium-sized fruits and vegetables, such as potatoes, zucchini, onions, cucumbers, carrots, apples, and more.



Manual



Code	Knives	Price
300.0250	Potato cutter with knife 10/12/15mm+pusher	16€
300.0251	Knife + pusher No. 10 mm	30€
30	Knife + pusher No. 12 mm	30€
30	Knife + pusher No. 15 mm	30

Code	Model	Power	Power	Knives	Dimensions	Price
300.0324	MEC-D001	230V/50Hz	4W	7/10/14mm	620x170x250mm	350€

Cooking appliances

Description

Sous Vide cooking machine. With a 360° water circulation system, the sous vide heats the water safely and evenly, quickly bringing it to the desired temperature. Its rear hook design is suitable for use with many types of containers. Easy to use in the kitchen or at home. Simply seal the food in a vacuum bag and then place it in a container with water. Place the slow cooker in the container and adjust the appropriate amount of water. Then turn on the device, press and hold the "ON" button, and the current temperature will appear on the display. Use the +/- buttons on the front panel to set the temperature and timer. Finally, when the food reaches the desired temperature and time, remove it and it is ready to serve. .



Ανοίγουμε την λαστιχένια τάπα για να απελευθερώνονται οι υδρατμοί.



Features

- LED display for visible operation and ease of use.
- Features an adjustable timer and temperature control system.
- Made entirely of stainless steel.
- Powerful and waterproof IPX7 tool
- Temperature sensors & heavy-duty timer
- Timer max 100h
- Bucket capacity: 5L - 40L
- Pump speed/circulation: 12L/min.

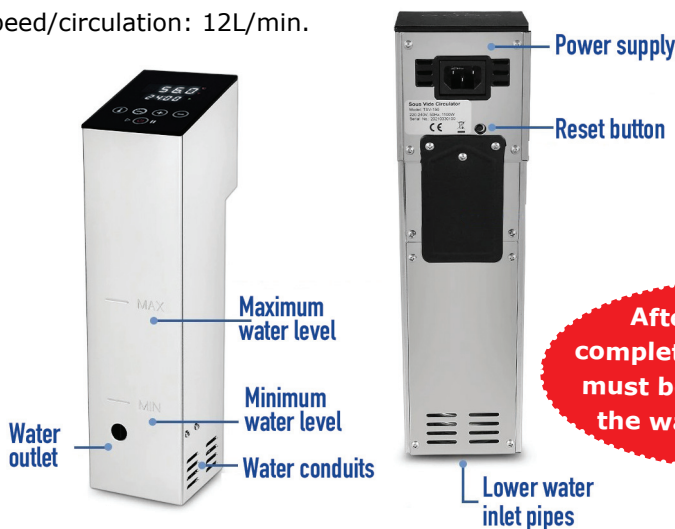
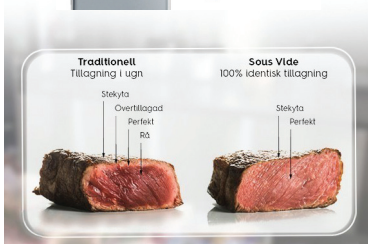
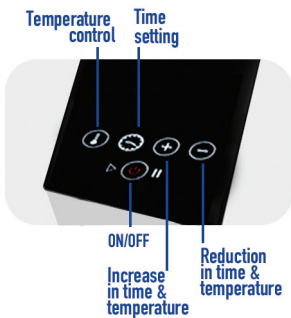

Scan to watch the video

After cooking is complete, the appliance must be removed from the water container.

Code	Model	Power supply	Power	Temperature	Weight	Dimensions mm	Price
300.5001	SVC150FS	230V/50Hz	2000W	0°-90°C	2.3Kg	90x115x356	350€

Cooking appliances

Provides accurate and consistent temperature control for even cooking. Can cook multiple foods at the same time. Suitable for homes, restaurants, hotels, and small kitchens.

SV-03A

- Stainless steel construction 201
- Heating capacity up to 30 liters of water
- Temperature range 5°-99°C
- Digital display showing time, temperature, and operation
- Automated cooking with time and temperature settings
- Quiet operation
- Low water level sensor.
- With special hook for attaching to the container and feet for adjusting the correct operating height
- With non-slip feet



After cooking is complete, the appliance must be removed from the water container.

SV-03B

- SS304 stainless steel construction
- Waterproof: IPX7
- Heating capacity up to 80 liters of water
- Large LCD display
- Easy-to-use digital control panel
- Automated cooking with time & temperature settings
- Low water level sensor
- Precise & stable temperature control for even cooking



Code	Model	Power supply	Power	Temperature	Weight	Dimensions mm	Price
300.0099	SV-03A	230V/50Hz	1500W	5°-99°C	1.68Kg	140x110x332	500€
300.5099	SV-03B	230V/50Hz	2000W	-	4,5Kg	160x196x419	800€



Cooking appliances

- Operating temperature indicator
- Stainless steel construction
- Five (5) program memories
- IP X3 protection
- Recommended uses GN 1/1 & 2/1
- Ideal for restaurants, catering
- Slow boiling in water
- High-precision thermometer with temperature control
- Applied to a container with a maximum depth of 16.5 cm using a clamp
- Circulation pump for better mixing of the product
- If the machine is operated without liquid, the thermometer is deactivated for safety reasons
- Temperature sensor to prevent overloading and overheating.

After cooking, the appliance must be removed from the water container

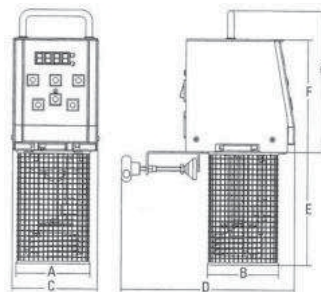

Ideal for restaurants and catering



Code	Model	Power supply	Power W	Weight	Temperature °C	Dimensions mm	Price
020.0800	XP	230V/50Hz	2000	40°-115°	4.5	A110*B105*C130*D260*E170*F170*G210	1300



020.0801

GN 1/1 480



020.0802

GN 2/1 700

Thermomix

- Mycook Pro is a latest-generation food processor for large quantities
- It can chop, mix, and cook simultaneously.
- The induction heating system heats food quickly and with precise temperature control
- The 4L bowl is made of stainless steel with a usable capacity of 2.5L
- The Turbo function and adjustable temperature range from 27°C to 160°C make it a versatile tool, essential for the modern kitchen.



Ideal for restaurants, bakeries, and catering services.



4-liter stainless steel bowl

	My Cook Pro
Code	020.0711
Power	2000
Power	230V/50Hz /1ph
Heating power	1000W
Timer	5-90 min
Speeds	20
Blade revolutions	50-7,250 rpm
Temperature	27÷160°C
Capacity	2.5L
Dimensions	300*290*380
Weight	6.5 kg
Price	€2,200



Scan to watch the video

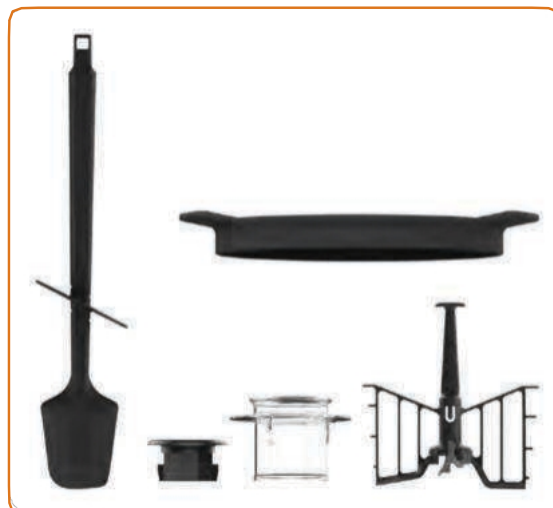

Accessories My Cook Pro



Thermomix

- The Dynamic Thermomixer is the latest generation of device for processing large quantities.
- It has the ability to chop, mix and cook simultaneously.
- The induction heating system has a temperature range of 37°C to 200°C.
- The 4 L bowl is made of stainless steel and has a safety lid.
- It has an easy-to-use touch screen with a menu of preset recipes and language support.
- Self-cleaning system with removable, dishwasher-safe parts.
- Accessories are included for every cooking need.



Code	Model	Power supply	Power	Capacity	Range temperature	Dimensions (L*W*H)mm	Price
303.0300	AIR-23	220V/50Hz	1750W	4L	37°-200°C	420*270*380	1500€

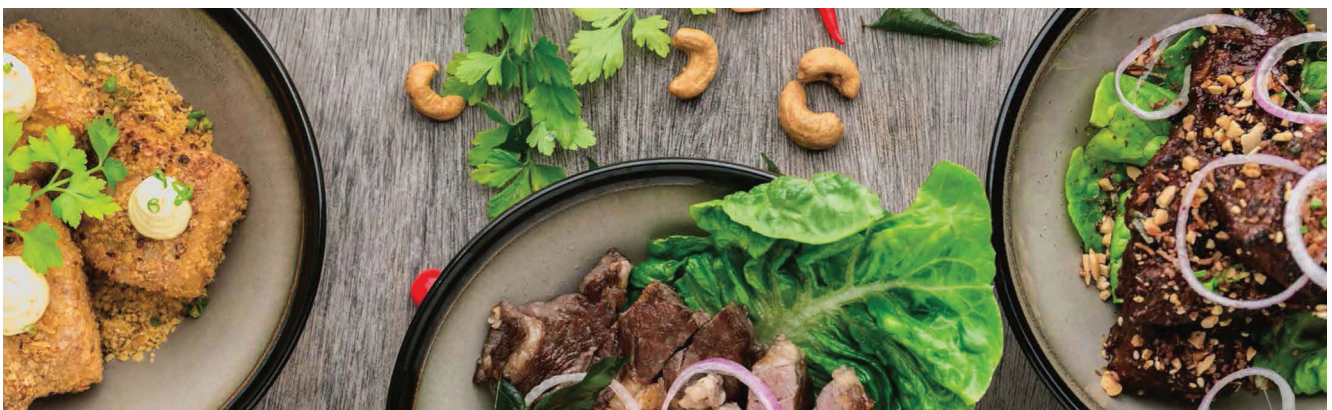

Gyros knife

- Prepare sliced meat in seconds
- 304 stainless steel blade
- ON/OFF switch
- With non-slip base
- Adjustment ring and screw for desired thickness
- Operates with rechargeable battery
- Battery life 4 hours
- With protective blade & overload protection button
- **The package also includes an extra battery and blade**



300.0285



300.0286



Code	Model	Power supply/Power	Weight Kg	Cutting depth	Output	Blade diameter mm	Dimensions (L*W*H) mm	Price
300.0280	KS100C	Battery ~12V 80W Lion	1.25	0-8mm	60Kg/h	Ø100	205*195*165	340€
300.0281	KS100T	230V/50Hz 80W	1.40	0-8mm	60Kg/h	Ø100	230*180*265	160€
300.0285	ICS Rotary Knife		-	-	-	-	-	40€
300.0286	ICS Kebab Cutter KS-100T Serrated Knife New		-	-	-	-	-	50€

KS80S ideal for gyros

Rotations: 8000rpm

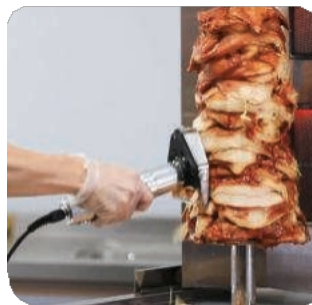

Code	Model	Power supply/Power	Weight Kg	Blade diameter mm	Dimensions (L*W*H) mm	Price
300.0282	KS80S	230V/50Hz/ 80W	3.8	Ø80	315*230*125	500€
300.0283	Straight Kebab Cutter KS80S Straight Knife New		-	-	-	70€
300.0284	Straight Kebab Cutter KS80S Serrated Knife New		-	-	-	80€

Maxidon Gyros knife

Κατασκευασμένο με εξαρτήματα υψηλής ποιότητας και εξοπλισμένο με λεπίδα από ανοξείδωτο ατσάλι, εξασφαλίζει λεπτό και ακριβές κόψιμο με μέγιστη αξιοπιστία.

- ✓ Ντονέρ
- ✓ Γύρος

**ΚΑΤΑΛΛΗΛΟ ΓΙΑ ΚΟΠΗ
ΟΛΩΝ ΤΩΝ ΕΙΔΩΝ ΓΥΡΟΥ**



Χαρακτηριστικά

Κωδικός	300.0287
Τροφοδοτικό	Τάση εισόδου: AC 220-240V / 50Hz Ισχύς εξόδου: 150 W Μήκος καλωδίου τροφοδοσίας: 2m
Ονομαστική ταχύτητα	8000 RPM
Λεπίδα	Διάμετρος 80mm (Ανοξείδωτο ατσάλι)
Ρυθμιζόμενο πάχος κοπής	0 -10mm
Ημερήσια ικανότητα κοπής	έως 100kg
Βάρος	925g
Τιμή	900€



ΑΠΟΣΠΟΜΕΝΗ ΚΕΝΤΡΙΚΗ ΜΟΝΑΔΑ

Σχεδιασμένο με αποσπώμενη κεφαλή για εύκολο καθάρισμα.
Η κεντρική μονάδα μπορεί να αφαιρεθεί και να καθαριστεί ξεχωριστά.



ΕΥΚΟΛΗ ΑΛΛΑΓΗ ΤΗΣ ΛΕΠΙΔΑΣ

Ο πρακτικός σχεδιασμός του διευκολύνει την αφαίρεση της λεπίδας είτε για καθάρισμα είτε για αντικατάσταση.



ΡΥΘΜΙΣΗ ΠΑΧΟΥΣ ΚΟΠΗΣ 0-10MM

Κατάλληλο για κοπή όλων των ειδών γύρου.



**ΚΑΤΑΣΚΕΥΑΖΕΤΑΙ ΕΞ ΟΛΟΚΛΗΡΟΥ ΣΤΟ
ΗΝΘΕΜΕΝΟ ΒΑΣΙΛΕΙΟ**

Fish Scalers

They are fully insulated from electricity and can withstand up to 4,000 volts. It is fully protected from water and moisture. The motor operates continuously. It can be plugged into a grounded or ungrounded outlet without any risk. The flexible drive shaft cover consists of two layers of steel, one layer of insulating material and one layer of plastic. The bearings at the top of the tool, which are used for cleaning fish, are waterproof and sealed. All external parts of the machine are made of stainless steel. The machine operates in accordance with all safety and user protection regulations.



Code	Model	Power supply	Power	Dimensions mm	Weight	Price
105.0010	KT-S	220-240V/50-60Hz	0.18kW	350*210*250	10Kg	2300€

Salad spinner

Ideal for lettuce.
12-25 litre bucket
Complies with food hygiene standards.
Available colours: Orange and green.



Code	Model	Capacity	Dimensions	Price
300.0211	JD-S338	12L/2.64 Gallons	320*435	150 €
300.0212	JD-S339	25L/5.5 Gallons	420*515	170 €



Dryer & Polisher for cutlery

- Ideal machine for quick and easy drying, polishing, and disinfecting
- Resistance drying
- Made of stainless steel
- Automatic operation
- With UV lamp for disinfection
- Polishing with a special food-grade brush

 *Ideal for restaurants, hospitals, catering, and hotels.*



Cutlery comes out completely dry and polished, ready for the table



Code	Model	Power	Power	Type	Output pcs/hour	Dimensions mm	Price
303.0104	DP-8C	230V/50Hz	750W	Tabletop	200	570x550x400	2400€
303.0105	DP-20C	230V/50Hz	850W	Wheeled	2000-2200	620x650x870	3400€



Glass polish

- Stainless steel construction
- Polishing brushes made of durable material with food safety certification
- With On-Off switch
- With hot air nozzle for fast and even drying
- Suitable for various glass sizes



HLBM001-A1



HLBM002-A1



HLBM005-A1

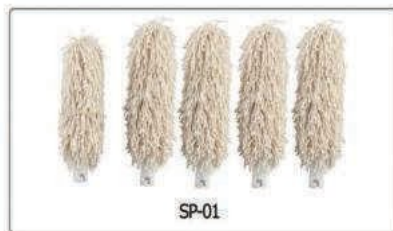

SP-01

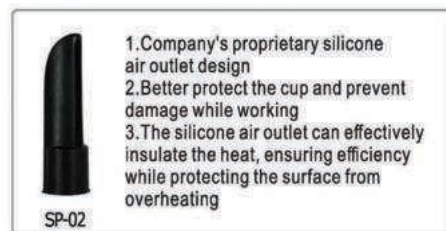

SP-02

1. Company's proprietary silicone air outlet design
2. Better protect the cup and prevent damage while working
3. The silicone air outlet can effectively insulate the heat, ensuring efficiency while protecting the surface from overheating

Product Series:	Fiber Glass Brush	Silicone cover
Product Code:	SP-01	SP-02

Code	Model	Power	Power	Brushes	Dimensions (L*W*H)mm	Price
303.0100	HLBM001-A1	230V/50Hz	1200W	5	310*310*500	760€
303.0103	HLBM002-A1	230V/50Hz	1200W	8	580*310*500	1500€
303.0101	HLBM005-A1	230V/50Hz	1200	5	280*340*510	900€

Glass and container rinsing device

- Stainless steel construction
- Ideal for washing glasses, containers and shakers measuring 3–10 cm.
- Suitable for restaurants, cafés and bars.



GLASS RINSER

Code	Υλικό	Dimension	Price
303.0500	SS201&0.65	178*168*65	60€



GLASS RINSER MECHANISM

Code	Υλικό	Dimension	Price
303.0509	-	-	25€



DYNAMIC GLASS RINSER

Code	Υλικό	Dimension	Price
303.0501	SS304&2.0mm	168*158*138	60€



DYNAMIC GLASS RINSER

Code	Υλικό	Dimension	Price
303.0502	SS201 & 2.0mm+ABS	140*130*28	50€



DYNAMIC GLASS RINSER

Code	Υλικό	Dimension	Price
303.0503	SS201&2.0mm	140*130*28	60€



Device for rinsing glasses and containers

- Made from stainless steel.
- Ideal for rinsing glasses, containers and shakers measuring 3–10 cm.
- Suitable for restaurants, cafés and bars.



DYNAMIC GLASS RINSER

Code	A UHfJU	Dimension	Price
303.0504	SS304&1.0mm	425*230*30	90€



DYNAMIC GLASS RINSER

Code	A UHfJU	Dimension	Price
303.0505	SS304&1.0mm	325*177*40	80€



DYNAMIC GLASS RINSER

Code	A UHfJU	Dimension	Price
303.0506	SS304&1.0mm	655*215*30	100€



DYNAMIC GLASS RINSER

Code	A UHfJU	Dimension	Price
303.0507	SS304&1.0mm	325*177*40	100€



DYNAMIC GLASS RINSER

Code	A UHfJU	Dimension	Price
303.0508	SS304&1.0mm	425*230*30	110€

Wall-mounted order base

- **Stainless steel construction**
- For easy order organization

Code	Dimension	Price
303.0800	300x80	16€
303.0801	500x80	18€
303.0802	600x80	22€
303.0803	800x80	26€
303.0804	1000x80	30€
303.0805	1200x80	34€

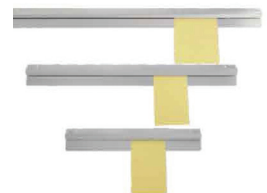

Foot-operated sink

- With valve for improved hygiene
- Easy installation-Durable construction
- 304 & 1.0mm sink
- With hands-free/foot-operated function**



CE

Code	Model	Dimensions mm	Price
300.0176	HS-S46	460*460*H950	400€

Sink

- With valve for improved hygiene
- Easy installation-Durable construction
- With hands-free function**



CE

Code	Model	Dimensions mm	Price
300.0170	HS-1	595*420*380	230€

Stainless steel bin

Stainless steel bin with pedal and wheels

- 50LT
- 100LT



Code	Model	Dimensions mm	Weight	Price
300.0174	Dynamic 50A Inox Bin 50Lt with pedal and wheels	ø350*600	8,7Kg	180€
300.0175	Dynamic 100A Inox Bin 100Lt with pedal and wheels	ø450*700	9.35Kg	200€

Hanging or wall-mounted fly trap



Fly traps with excellent design and two installation options.

Hanging (50-60m²) and wall-mounted.

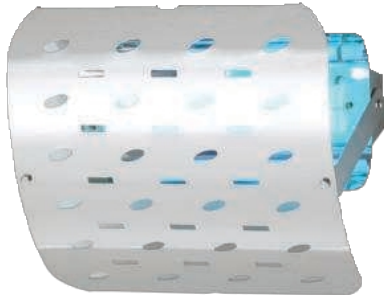

	CL6.2	GLUE	LAMP
Code	104.001	104.0010	-
Coverage	60m	-	-
Dimensions mm	260x245x145	-	-
Adhesive	265x220	265x220	--
Weight	1.7 kg	-	-
Power	0.025kW	-	0.018kW
Power supply	230V/50Hz		230V/50Hz
Price	190.00€	8,00 €	

Hanging or wall-mounted fly trap

Fly traps with excellent design and two installation options. **Hanging (100-120m²) and wall-mounted.**

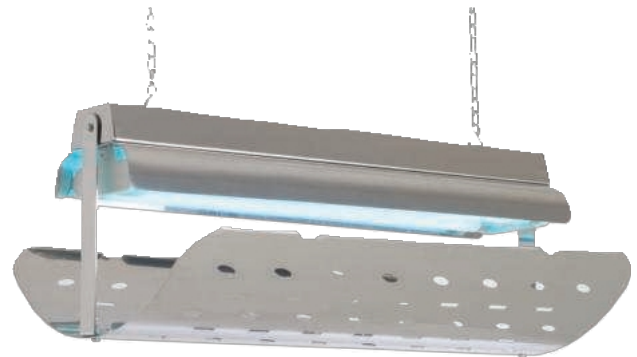

	CL16.3	GLUE	LAMP
Code	104.0014	104.0013	-
Coverage	120m	-	-
Dimensions mm	490x312x200	-	-
Adhesive	450x370	450x370mm	--
Weight	3.3Kg	-	-
Power	0.03kW	-	0.015kW
Power supply	230V/50Hz		230V/50Hz
Price	210.00€	10,00 €	





Heated display
cases

Refrigerated
display cases

Refrigerators

Heated tabletop display case



Features

- Adjustable temperature control
- Stainless steel front
- Curved glass front
- Glass sliding rear doors

Technical specifications

Display case type	Heated
Doors	2
Power supply (V/Hz)	230/50
Door type	Sliding
Heating system	Resistance

GN trays included

	RTF3	RTF5	RTF8
Code	300.0927	300.0928	300.0929
Dimensions mm	862*420*336	1394*420*336	1483*420*336
Capacity	51L	85L	90L
Internal Temperature	30~90°C	30~90°C	30~90°C
Power (W)	50	100	1000
Shelves	3 1/2GN-40	5 1/2GN-40	8 1/2GN-40
Price	750€	940€	1050 €



Heated tabletop display case

Features

- Stainless steel construction with non-slip feet
- Sliding doors
- With 3 fixed shelves
- LED lighting
- Manual temperature control with indicator



Technical specifications

Type of display case	Heated
Doors	2
Power supply (V/Hz)	230/50
Door type	Sliding
Heating system	Resistance

	FDW-701	FDW-702	FDW-703
Code	300.0923	300.0924	300.0925
Dimensions	370*450*590	630*450*590	890*450*590
Capacity	-	-	-
Internal temperature	30~85°C	30~85°C	30~85°C
Power (W)	1000	120	150
Shelves	3	3	3
Price	340€	430€	570€

Heated tabletop display case in black

Features

- Heating pipe
- LED lighting
- Manual temperature control with indicator
- Stainless steel base
- Double glazing
- With 3 adjustable shelves



Technical

Type of display case	Heated
Doors	2
Power supply (V/Hz)	220~240/50
Door type	Sliding
Heating system	Resistance

	GN-660HRT	GN-900HRT	GN-1200HRT
Code	300.0945	300.0946	300.0948
Dimensions	660*530*730	900*530*730	1200*530*730
Capacity	102	140	190
Internal Temperature	40~65°C	40~65°C	40~65°C
Power (W)	450	460	910
Shelves	3	3	3
Price	€850	€930	€1,150



Heated tabletop stainless steel display case

Features

- Heating pipe
- LED lighting
- Manual temperature control with indicator
- Stainless steel base
- Double glazing
- With 2 adjustable shelves



Technical	
Type of display case	Heated
Doors	2
Power supply (V/Hz)	220~240/50
Door type	Sliding
Heating system	Resistance

	GN-660HRT	GN-900HRT	GN-1200HRT
Code	300.0921	300.0920	300.0912
Dimensions mm	660*530*730	900*530*730	1200*530*730
Capacity	102	140	190
Internal temperature	40~65°C	40~65°C	40~65°C
Power (W)	450	460	910
Shelves	2	2	2
Price	€850	€930	€1,150

Heated Display Case

Features

- Adjustable temperature controller
- Stainless steel construction
- Non-adjustable shelves
- 2 front doors with hinges
- 2 rear doors with hinges



	FTR-80L
Code	300.0968
Dimensions	700*400*377
Capacity	80
Internal temperature	30~90°C
Power (W)	1000
Doors	4
Price	400€

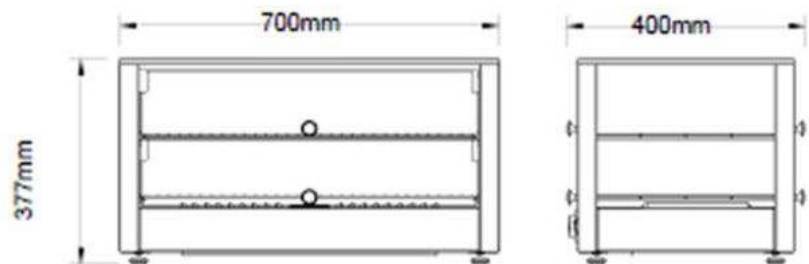

FTR-80L

Heated Display Case

Features

- Adjustable temperature regulator
- Stainless steel construction
- Internal LED lighting on the sides
- Non-adjustable shelves
- 3 front doors with hinges
- 3 doors with hinges at the back



	FTR-115L
Code	300.0963
Dimensions	700*400*503
Capacity	115L
Internal temperature	30~90°C
Power (W)	1250
Doors	6
Price	440€

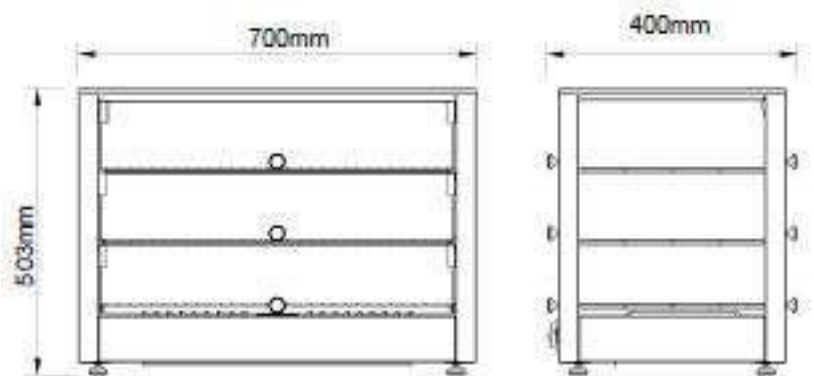

FTR-115L

Heated display cases



Features

- Adjustable temperature regulator
- Stainless steel construction



Technical	
Display case type	Heated
Power supply (V/Hz)	220~240/50
Door type	Hinged
Heating system	Resistance

FTR-50L	
Code	300.0962
Dimensions	561*379*371
Capacity	50L
Internal temperature	30~90°C
Power (W)	80
Doors	2
Price	350€

Refrigerated tabletop display case, stainless steel

Features

- Stainless steel base
- LED lighting
- Electronic thermostat
- Double glazing
- With 2 adjustable shelves



Technical specifications

Type of display case	R290
Coolant	coolin
Doors	g 2
Power supply (V/Hz)	220~240/50
Door type	Sliding
Cooling system	Rapid cooling

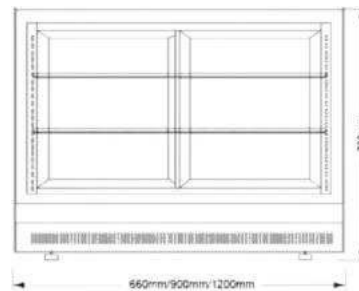

	GN-660RT	GN-900RT	GN-1200RT
Code	300.0911	300.0910	300.0922
Dimensions	660*530*730	900*530*730	1200*530*730
Capacity	102	140	190
Internal temperature	2~8°C	2~8°C	2~8°C
Power (W)	250	350	360
Shelves	2	2	2
Price	€1,050	€1,140	€1,360



Refrigerated table in black color

Features

- Stainless steel base
- LED lighting
- Electronic thermostat
- Double glazing
- 2 adjustable shelves



Technical specifications

Type of display case	Cooling
Coolant	R290
Doors	2
Power supply (V/Hz)	220~240/50
Door type	Sliding
Cooling system	Rapid cooling

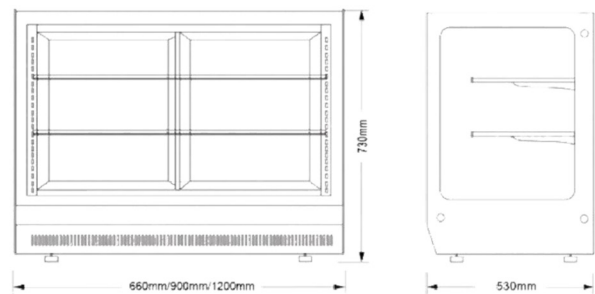

	GN-660RT	GN-900RT	GN-1200RT
Code	300.0944	300.0947	300.0949
Dimensions mm	660*530*730	900*530*730	1200*530*730
Capacity	102	140	190
Internal Temp	2~8°C	2~8°C	2~8°C
Power (W)	250	350	360
Shelves	2	2	2
Price	1.050€	1.140€	1.360€



Refrigerated tabletop Showcase



Features

- Internal LED lighting
- Digital temperature controller with display
- Adjustable, PVC-coated shelves
- Double glazing on all sides
- Maintenance-free condenser
- Ventilated cooling system
- Automatic defrosting
- Air vent outside the glass for removing condensation water

	FT-58L	FT-68L
Code	300.0919	300.0918
Dimensions mm	-	452*406*893
Capacity	58L	68L
Internal Temp	0~12°C	0~12°C
Power (W)	245/250	245/250
Shelves	2	3
Price	510€	550€

Technical specifications

Type of display case	Cooling
Coolant	R290
Power supply (V/Hz)	220~240/50
Door type	Sliding
Cooling system	Rapid cooling

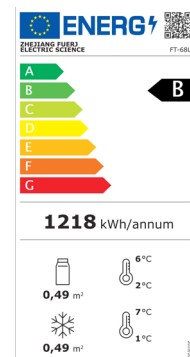
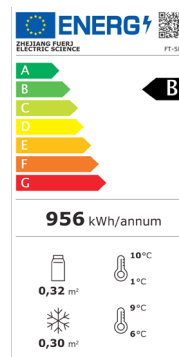

Neutral Showcase



Features

- Hard and durable display glass that makes it resistant to knocks and scratches
- Stainless steel base

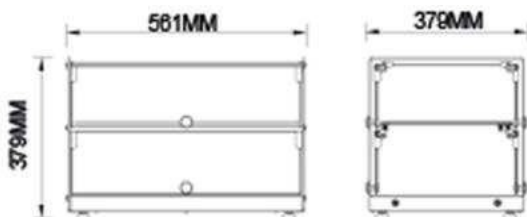

	FTZ-50L
Code	300.0964
Dimensions	561*379*371
Capacity	50
Doors	2
Weight	11.9 kg
Price	220€

Neutral Showcase

Features

- Hard and durable display case glass that makes it resistant to knocks and scratches
- Sliding door type



FTZ-115Z



FTZ-65Z



FTZ-80Z

	FTZ-65Z	FTZ-85Z	FTZ-115Z
Code	300.0965	300.0966	300.0967
Dimensions mm	568*388*391	743*388*391	933*388*391
Capacity	65	85	115L
Doors	2	2	2
Weight	17Kg	21 kg	25
Price	260€	300€	330€

GN-620FX Black Beverage Fridge



Features

- Interior lighting LED
- Digital temperature controller with display
- Double glazing on all sides
- The condenser does not require maintenance
- Automatic defrosting
- Automatic door closing
- LOW-E safety glass, transparent



	GN-620FX
Code	300.0970
Dimensions mm	620*600*1848
Capacity	360L
Internal Temp	2~8°C
Power (W)	245/250
Shelves	5
Price	760€

Technical specifications

Type of display case	Cooling
Coolant	R290
Power supply (V/Hz)	220/50
Door type	Opening
Cooling system	Rapid cooling

GN-410FS Black Beer Fridge



	GN-410FS
Code	300.0969
Dimensions mm	620*700*1998
Capacity	450L
Internal Temp	-5~+5°C
Power (W)	245/250
Shelves	5
Price	1100€

Features

- Interior lighting LED
- Digital temperature controller with display
- Double glazing on all sides
- The condenser does not require maintenance
- Automatic defrosting
- Automatic door closing
- LOW-E safety glass, transparent

Technical specifications

Type of display case	Cooling
Coolant	R290
Power supply (V/Hz)	220/50
Door type	Opening
Cooling system	Rapid cooling

GN-1250FX *Black Double Refrigerator*

Features

- Interior lighting LED
- Digital temperature controller with display
- Double glazing on all sides
- The condenser does not require maintenance
- Automatic defrosting
- Automatic door closing
- LOW-E safety glass, transparent



Technical specifications

Type of display case	Cooling
Coolant	R290
Power supply (V/Hz)	220/50
Door type	Opening
Cooling system	Rapid cooling

GN-1250FX	
Code	300.0972
Dimensions mm	1250*720*1998
Capacity	1060/810L
Internal Temp	2~8°C
Power (W)	245/250
Shelves	5
Price	1900€

GN-410FS Black Refrigerator



Features

- Interior lighting LED
- Digital temperature controller with display
- Double glazing on all sides
- The condenser does not require maintenance
- Automatic defrosting
- Automatic door closing
- LOW-E safety glass, transparent

	GN-410FS
Code	300.0974
Dimensions mm	620*700*1998
Capacity	410L
Internal Temp	2~8°C
Power (W)	245/250
Shelves	5
Price	960€



Technical specifications

Type of display case	Cooling
Coolant	R290
Power supply (V/Hz)	220/50
Door type	Opening
Cooling system	Rapid cooling

GN-460FDM Freezer



Features

- Interior lighting LED
- Digital temperature controller with display
- Double glazing on all sides
- With cooling racks
- The condenser does not require maintenance
- Automatic defrosting
- Automatic door closing
- LOW-E safety glass, transparent

	GN-460FDM
Code	300.0971
Dimensions mm	685*600*1998
Capacity	400L
Internal Temp	-18~22°C
Power (W)	245/250
Shelves	5
Price	1800€

Technical specifications

Type of display case	Cooling
Coolant	R290
Power supply (V/Hz)	220/50
Door type	Opening
Cooling system	Static Cooling

Soft Drink Showcase



Features

- Adjustable Shelves
- Maintenance-free condenser
- Ventilated Cooling system
- Automatic defrosting
- Air vent outside the window for removing condensation water



	EC-450W
Code	300.0938
Dimensions mm	660*650*2050
Capacity	450L
Internal Temp	0~10°C
Power	230V/50Hz
Shelves	4
Price	1.100€

Technical specifications

Type of display case	Cooling
Coolant	R290/90g
Power supply (V/Hz)	230/50
Cooling system	Rapid cooling

Soft Drink Showcase



Features

- Interior: White steel plate
- Exterior: Black steel plate
- Door opening with automatic closing
- LED interior lighting at the top
- Adjustable shelves
- Digital temperature controller
- Front panel made of LOW-E safety glass, transparent



	GN-150HL
Code	300.0973
Dimensions mm	400*455*1951
Capacity	150L
Internal Temp	2~8°C
Power	230
Shelves	4
Price	650€

Technical specifications

Type of display case	Cooling
Coolant	R290
Power supply (V/Hz)	230/50
Cooling system	Static Cooling

Refrigerated Table Top Showcase



Features

- Front glass panel
- Sliding doors
- LED lighting
- Digital temperature controller with display
- Evaporator with tray at the top for collecting condensation
- 1/3GN

GN trays are included

Technical specifications

Type of display case	Cooling
Coolant	R290
Power supply (V/Hz)	230/50
Cooling system	Static Cooling

	FS-44L-2	FS-64L-2	FS-84L-2
Code	300.0941	300.0942	300.0943
Dimensions mm	1131*395*375	1307*395*375	1483*395*375
Shelves	4*1/3 GN	5*1/3 GN	6*1/3 GN
Internal Temp	2~12°C	2~12°C	2~12°C
Power (W)	180	180	180
Weight	43Kg	47Kg	51Kg
Price	900€	960€	1100€

Suchi refrigerated tabletop Showcase



GN trays are included

Features

- LED lighting at the top
- Digital temperature controller with display
- Sliding doors
- Curved glass front
- Evaporator with tray at the top for collecting condensation

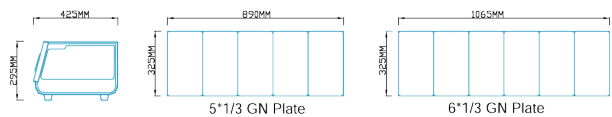

FS-52Z

FS-62Z

	FS-52Z	FS-62Z
Code	300.0936	300.0937
Dimensions mm	1352*425*295	1529*425*295
Shelves	5*1/3 GN	6*1/3 GN
Internal Temp	2~12°C	2~12°C
Power (W)	180	180
Weight	42Kg	44Kg
Price	860€	1000€

Technical specifications

Type of display case	Cooling
Coolant	R290
Power supply (V/Hz)	230/50
Cooling system	Static Cooling

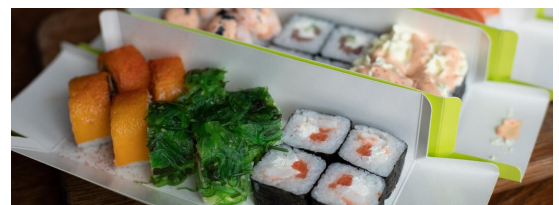

Suchi refrigerated tabletop Showcase

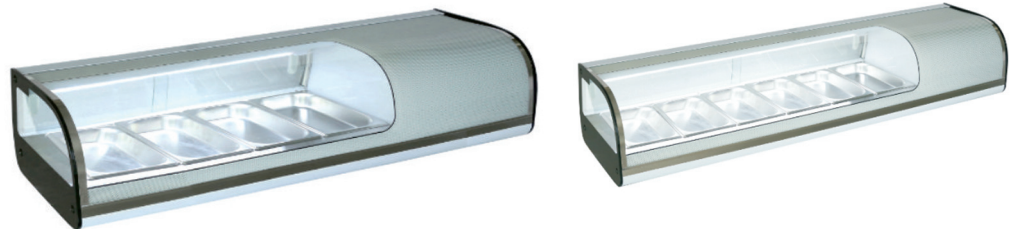

Features

- Stainless steel construction
- LED lighting
- Quiet operation
- High-quality compressor
- Digital temperature control
- With 1/3 trays

GN trays are included

Technical specifications

Type of display case	Cooling
Coolant	R290/600a
Power supply (V/Hz)	230/50
Cooling system	Static Cooling



	GN-42	GN-52	GN-62
Code	300.0915	300.0916	300.0917
Dimensions mm	1160*420*315	1340*420*315	1510*420*315
Capacity	4*1/3 GN	5*1/3 GN	6*1/3 GN
Internal Temp	0~12°C	0~12°C	0~12°C
Power (W)	125	135	145
Capacity	42L	52L	62L
Price	750€	800€	1000€

Back Bar Cooler Inox

Features

- Stainless steel door
- Interior with embossed aluminum
- With 2 adjustable shelves
- LED lighting



GN-126L

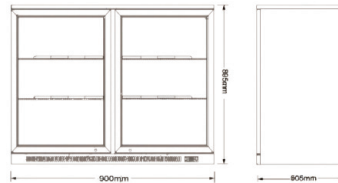

GN-220L

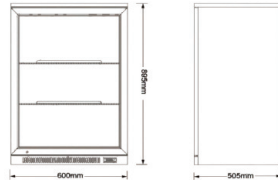

GN-320L

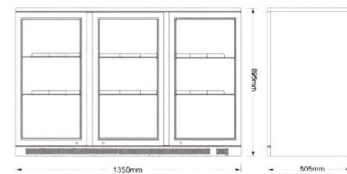

Technical specifications

Type of display case	Cooling
Coolant	R290/600a
Doors	1/2/3
Power supply (V/Hz)	220~240/50
Cooling system	Rapid cooling

	GN-126L	GN-220L	GN-220LS	GN-320L	GN-320LS
Code	300.0905	300.0906	300.0907	300.0908	300.0909
Dimensions mm	600*505*895	900*505*895	900*505*895	1335*505*895	1335*505*895
Capacity	126	220	220	320	320
Internal Temp	2~8°C	2~8°C	2~8°C	2~8°C	2~8°C
Power (W)	250	280	350	350	350
Shelves	2	2	2	2	2
Doors	1 Opening	2 Opening	2 Sliding	3 Opening	3 Sliding
Price	880€	1.170€	1.200€	1.500€	1.420€

Back Bar Cooler All Inox

Features

- Exterior: Stainless steel
- Interior: Stainless steel with mirror finish
- Digital temperature controller
- LED lighting
- With 2 adjustable shelves in white, steel



GN-220L-ASS



GN-320L-ASS



The door frame is made of a special aluminum alloy.

Technical specifications

Type of display case	Cooling
Coolant	R290/600a
Doors	1/2/3
Power supply (V/Hz)	220~240/50
Cooling system	Rapid cooling



	GN-220L-ASS	GN-320L-ASS	GN-320LS-ASS
Code	300.0994	300.0995	300.0996
Dimensions mm	900*505*845	1335*505*845	900*505*845
Capacity	220	320	320
Internal Temp	+2~8°C	+2~8°C	+2~8°C
Power (W)	280	350	350
Shelves	2	2	2
Doors	2 Opening	3 Opening	3 Sliding
Price	1.170€	1.500€	1.420€

Back Bar Cooler (Regular)

Features

- Sliding door / Door with hinges
- Interior with embossed aluminum
- With 2 adjustable shelves
- LED lighting



GN-220H



GN-126H

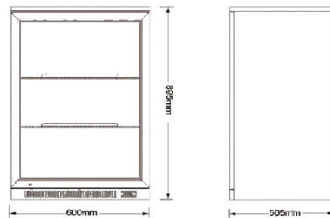

GN-320H

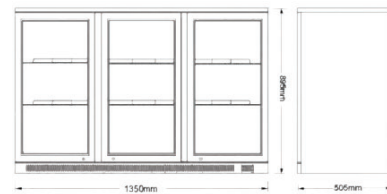
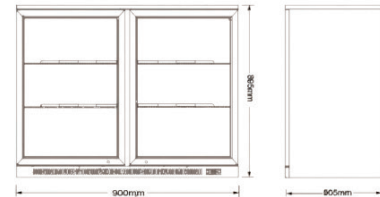

Technical specifications

Type of display case	Cooling
Coolant	R290/600a
Doors	1/2/3
Power supply (V/Hz)	220~240/50
Cooling system	Rapid cooling

	GN-220H	GN-320H	GN-220HS	GN-320HS	GN-126H
Code	300.0900	300.0901	300.0902	300.0903	300.0904
Dimensions mm	900*505*895	1335*505*895	900*505*895	1335*505*895	600*505*895
Capacity	220	320	220	320	126
Internal Temp	2~8°C	2~8°C	2~8°C	2~8°C	2~8°C
Power (W)	280	350	280	350	250
Shelves	2	2	2	2	2
Doors	2 Opening	3 Opening	2 Sliding	3 Sliding	1 Opening
Price	980€	1.190€	1.030€	1.270€	660€

Back Bar Cooler All Black

Features

- Sliding door / Hinged door
- Exterior: Black steel frame with matte finish
- Interior: Black steel frame
- Double low-e glass (low-e) transparent
- LED interior lighting
- With 2 adjustable shelves in white, steel
- Integrated door frame made of black plastic



Technical specifications

Type of display case	Cooling
Coolant	R290/600a
Doors	1/2/3
Power supply (V/Hz)	220~240/50
Cooling system	Rapid cooling

	GN-126HBL/BL	GN-220HBL/BL	GN-220HSBL/BL	GN-320HBL/BL
Code	300.0990	300.0991	300.0993	300.0992
Dimensions mm	600*505*845	900*505*845	900*505*845	1350*505*845
Capacity	220	220	220	220
Internal Temp	2~8°C	2~8°C	2~8°C	2~8°C
Power (W)	280	280	280	280
Shelves	2	2	2	2
Doors	1 Opening	2 Opening	2 Sliding	3 Opening
Price	660€	980€	1.030€	1.190€

Salad bar Showcase



GN-1130SB

Features

- Stainless steel base
- LED lighting
- Digital temperature control
- With G/N 1/3
- 100% stainless steel construction

GN trays are included

Technical specifications

Type of display case	Cooling
Coolant	R290/600a
Power supply (V/Hz)	230/50
Cooling system	Rapid cooling

	GN-1130SB	GN-1305SB	GN-1480SB	GN-1655SB	GN-1830SB
Code	300.0931	300.0932	300.0933	300.0934	300.0935
Dimensions mm	1130*395*435	1305*395*435	1480*395*435	1655*395*435	1830*395*435
Capacity	42L	52L	62L	72L	82L
Internal Temp	2~12°C	2~12°C	2~12°C	2~12°C	2~12°C
Power (W)	130	135	142	150	165
Trays	4	5	6	7	8
Price	700€	750€	800€	900€	1000€



GN-1305SB
5 trays

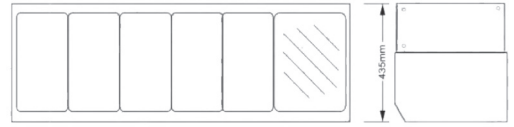

GN-1480SB
6 trays

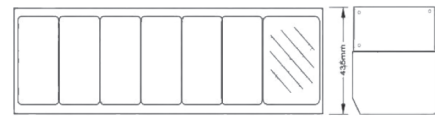

GN-1655SB
7 trays

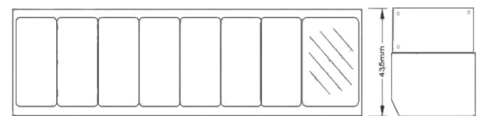

GN-1830SB
8 trays

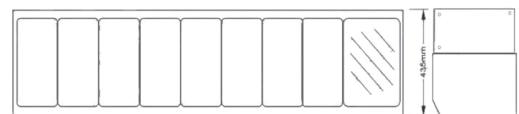

Salad bar Showcase



DT48TW
5 trays

Features

- Stainless steel base
- LED lighting
- Digital temperature control
- With G/N 1/4
- 100% stainless steel construction

GN trays are included

Technical specifications

Type of display case	Cooling
Coolant	R290
Power supply (V/Hz)	220/50
Cooling system	Rapid cooling

	D40TW	D48TW	D55TW	D60TW	D71TW
Code	300.4900	300.4901	300.4902	300.4903	300.4904
Dimensions mm	1130*335*450	1305*335*450	1480*335*450	1655*335*450	1830*335*450
Capacity	42L	52L	62L	72L	82L
Internal Temp	2~12°C	2~12°C	2~12°C	2~12°C	2~12°C
Power (W)	130	135	142	150	165
Trays	4x1/4GN	5x1/4GN	6x1/4GN	7x1/4GN	8x1/4GN
Price	700€	750€	800€	900€	1000€



DT40TW
4 trays

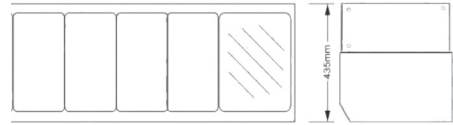

DT55TW
6 trays

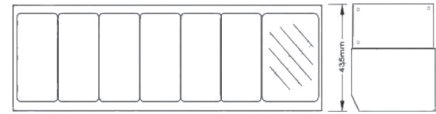

DT60TW
7 trays

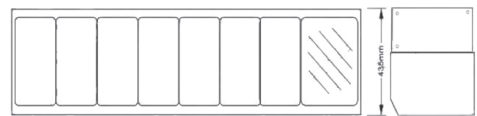

DT71TW
8 trays

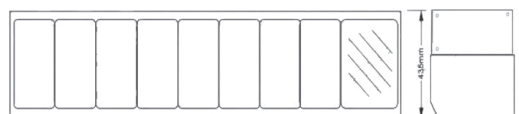

JC 132E 46-bottle wine cooler

Wine refrigerator with independent temperature zones, ideal for storing both red and white wines at their ideal serving temperatures. The advanced digital control system ensures precision and consistency, allowing you to easily adjust and monitor temperature settings. The compressor system operates quietly and efficiently, minimizing vibrations and disturbances that could potentially affect the quality of your wines.

Features

- Durable construction
- Sleek and modern design
- Built-in & freestanding installation
- Temperature memory function
- Adjustable thermostat
- Customizable shelf options
- With internal fan (to prevent frost)
- Security lock system (optional)

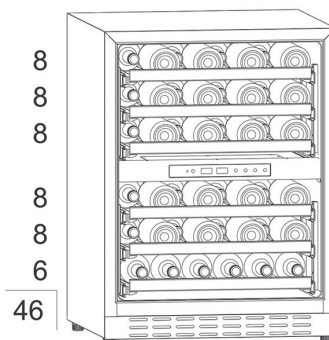
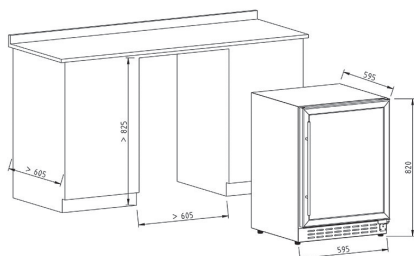

EPREL

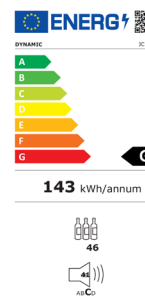

	JC132E Dual Zone Black
Code	302.0001
Wine capacity	46 bottles
Capacity	132 liters
Temperature zones	2
Temperature	5–10°C (41–50°F) for the upper zone 10–18°C (50–64°F) for the lower zone
Configuration	Single door with double glazing
Control type	Electronic
Door orientation	Reversible
Interior lighting Wine	Blue LED
shelves	6 wooden shelves
Refrigerator dimensions	595 x 595 x 870 mm
Price	880€



Electronic control LED display



JC 95B 32-bottle wine cooler

Wine refrigerator with independent temperature zones, ideal for storing both red and white wines at their ideal serving temperatures. The advanced digital control system ensures precision and consistency, allowing you to easily adjust and monitor temperature settings. The compressor system operates quietly and efficiently, minimizing vibrations and disturbances that could potentially affect the quality of your wines.

Features

- Sleek and modern design
- Built-in & freestanding installation
- Temperature memory function
- Adjustable thermostat
- Customizable shelving options
- With internal fan (to prevent frost)
- Security lock system (optional)
- Durable construction for reliable performance.



Electronic control LED display

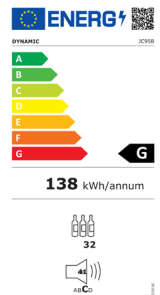

EPREL

	JC95B Dual Zone Black
Code	302.0000
Wine capacity	32 bottles
Capacity	95 liters
Temperature zones	2
Temperature	5–10°C (41–45°F) for the upper zone 10–18°C (50–64°F) for the lower zone
Configuration	Single door with triple-pane glass
Control type	Electronic
Door orientation	Reversible
Interior lighting Wine	Blue LED
shelves	4 wooden shelves
Refrigerator dimensions	450 x 595 x 820 mm
Price	780€



JC 415 146-bottle wine cooler

Wine refrigerator with independent temperature zones, ideal for storing both red and white wines at their ideal serving temperatures. The advanced digital control system ensures precision and consistency, allowing you to easily adjust and monitor temperature settings. The compressor system operates quietly and efficiently, minimizing vibrations and disturbances that could potentially affect the quality of your wines.

Features

- Sleek and modern design
- Built-in & freestanding installation
- Temperature memory function
- Adjustable thermostat
- Customizable shelving options
- With internal fan (to prevent frost)
- Security lock system (optional)
- Durable construction for reliable performance.



Electronic control LED display

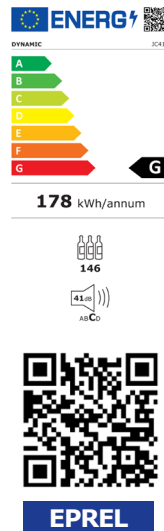

	JC415 Dual Zone Black
Code	302.0002
Wine capacity	146 bottles
Capacity	415 liters
Temperature zones	2
Temperature	5–10°C (41–45°F) for the upper zone 10–18°C (45–64 °F) for the lower zone
Configuration	Single door with triple glazing
Control type	Electronic
Door orientation	Reversible
Interior lighting Wine	Blue LED
shelves	15 wooden shelves
Refrigerator dimensions	595*680*1847mm
Price	1800€





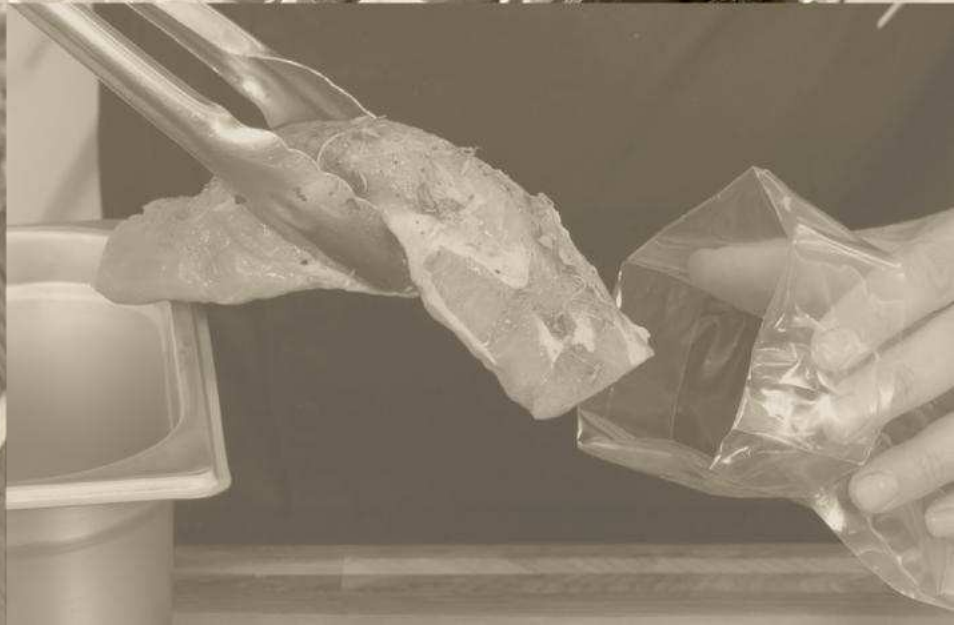

TOUCH SMART

- Entirely made of AISI 304 stainless steel
- **7" touch control panel**, waterproof and scratch-resistant.
- With **9 programs** designed for vacuum packaging of food and 100 programmable memories.
- Pump dehumidification program and 5 levels of air inflow speed adjustment for sensitive products.
- Removable glue sticks for easier cleaning, transparent plexiglass lid.
- In the automatic program it recognizes the product that is placed inside the chamber and automatically adjusted to obtain the maximum under pressure to preserve the product thanks to the vacuum sensor and detection system.

Internal Suction



Ideal for professional catering, delicatessen, bar, packaging, beverage production, restaurants

Tabletop

In each cycle, it prints the product description, packaging date, expiration date, batch code.



TOUCH SMART 50C - 2/50C Trolley



Bag sealing



Oxygen warning 21% >

Programs

Automatic AUTO	% vacuum %	vacuum program seconds
Marinade ~~~~~	Shellfish 🦀	Liquid 💧
Jar 📦	Volatilization mBar	Osmosis 💧

Optional upon request



Inert gas system Built-in



Printer. Printing speed 80mm/s
Thermal paper 57x30mm x 12 **LINERLESS**
paper Quick installation



Bag cutting



External label printer. Print speed 200 mm/s. Self-adhesive thermal paper 100x100



System that removes air from the chamber



Inclined surface especially when the food has liquids to prevent them from running towards the sealing bar



Ethernet connection



WiFi connection

Touch Smart vacuum series

TOUCH SMART 32



TOUCH SMART 35



TOUCH SMART 41



TOUCH SMART 50



TOUCH SMART 2/50



TOUCH SMART 50C - 2/50C

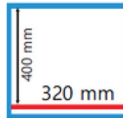

TOUCH SMART 32

Welding bar 320mm

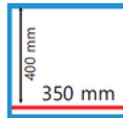

TOUCH SMART 35

Welding bar 350mm

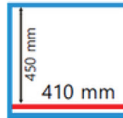

TOUCH SMART 41

Welding bar 410mm

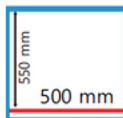

TOUCH SMART 50 - TOUCH SMART 50C

Welding bar 500mm

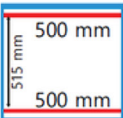

TOUCH SMART 2/50 - TOUCH SMART 2/50C

Welding bar 2/500mm

Model	Machine dimensions	Chamber dimension	Vacuum pump	Sealing bar	Inert gas (optional)	Power	Weight	Max bag
TOUCH 32	390x530x320 mm	330x400x175 mm	8m ³ /h	320 mm	1	220 V-50-60 Hz 800 w	43kg	300x400 mm
TOUCH 35	422x530x323mm	360x400x175 mm	12m ³ /h	350 mm	1	220 V-50-60 Hz 1200 w	45kg	350x400 mm
TOUCH 41	506x580x355 mm	417x464x180 mm	25m ³ /h	410 mm	2	220 V-50-60 Hz 1500 w	55kg	400x450 mm
TOUCH 50	612x667x370 mm	512x550x200 mm	25m ³ /h	510 mm	2	220 V-50-60 Hz 1500 w	75kg	500x550 mm
TOUCH 2/50	612x667x370 mm	512x550x200 mm	25m ³ /h	2 x 510 mm	4	220 V-50-60 Hz 2300 w	75kg	500x550 mm
TOUCH 50C	612x667x900 mm	512x550x200 mm	25m ³ /h	510 mm	2	220 V-50-60 Hz 1500 w	85kg	500x550 mm
TOUCH 2/50C	612x667x900 mm	512x550x200 mm	25m ³ /h	2 x 510 mm	4	220 V-50-60 Hz 2300 w	85kg	500x550 mm

SMART PROFESSIONAL

- Entirely made of AISI 304 stainless steel
- **5" touch control panel**, waterproof and scratch-resistant.
- With 8 programs designed for vacuum packaging of food and **20 programmable memories**.
- Pump dehumidification program and 5 levels of air inflow speed adjustment for sensitive products.
- Removable glue sticks for easier cleaning, transparent plexiglass lid.
- In the automatic program it recognizes the product that is placed inside the chamber and automatically adjusted to obtain the maximum under pressure to preserve the product thanks to the vacuum sensor and detection system.

Internal Suction



Ideal for professional catering, delicatessen, bar, packaging, beverage production, restaurants

Tabletop

In each cycle, it prints the product description, packaging date, expiration date, batch code.



SMART 50C - 2/50C Trolley



Bag sealing



Oxygen warning 21% >

Programs

Automatic AUTO	% vacuum %	vacuum program seconds
Marinade ~~~~~	Shellfish 🦞	Liquid 💧
Jar 📦	Volatilization mBar	

Optional upon request



Inert gas system Built-in



**Printer. Printing speed 80mm/s
Thermal paper 57x30mm x 12 LINERLESS
paper Quick installation**



Bag cutting



**External label printer. Print speed 200
mm/s. Self-adhesive thermal paper 100x100**



System that removes air from the chamber



**Inclined surface especially when the food has
liquids to prevent them from running
towards the sealing bar**



Ethernet connection



WiFi connection

SMART
PROFESSIONAL

Smart Professional vacuum series

SMART 32



SMART 35



SMART 41



SMART 50



SMART 2/50



SMART 50C - 2/50C

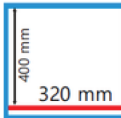

SMART 32

Welding bar 320mm

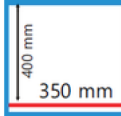

SMART 35

Welding bar 350mm

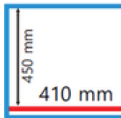

SMART 41

Welding bar 410mm

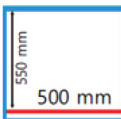

SMART 50 - SMART 50C

Welding bar 500mm

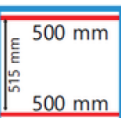

SMART 2/50 - SMART 2/50C

Welding bar 2/500mm

Model	Machine dimensions	Chamber dimension	Vacuum pump	Sealing bar	Inert gas (optional)	Power	Weight	Max bag
SMART 32	390x530x320 mm	330x400x175 mm	8m ³ /h	320 mm	1	220 V-50-60 Hz 800 w	43kg	300x400 mm
SMART 35	422x530x323mm	360x400x175 mm	12m ³ /h	350 mm	1	220 V-50-60 Hz 1200 w	45kg	350x400 mm
SMART 41	506x580x355 mm	417x464x180 mm	25m ³ /h	410 mm	2	220 V-50-60 Hz 1500 w	55kg	400x450 mm
SMART 50	612x667x370 mm	512x550x200 mm	25m ³ /h	510 mm	2	220 V-50-60 Hz 1500 w	75kg	500x550 mm
SMART 2/50	612x667x370 mm	512x550x200 mm	25m ³ /h	2 x 510 mm	4	220 V-50-60 Hz 2300 w	75kg	500x550 mm
SMART 50C	612x667x900 mm	512x550x200 mm	25m ³ /h	510 mm	2	220 V-50-60 Hz 1500 w	85kg	500x550 mm
SMART 2/50C	612x667x900 mm	512x550x200 mm	25m ³ /h	2 x 510 mm	4	220 V-50-60 Hz 2300 w	85kg	500x550 mm

DVA PROFESSIONAL

- Entirely made of AISI 304 stainless steel
- **5" control panel**, waterproof and scratch-resistant.
- With 4 programs designed for vacuum packaging of food and **20 programmable memories**.
- Pump dehumidification program.
- Removable glue sticks for easier cleaning, transparent plexiglass lid.
- The DVA series features programs with time or vacuum percentage selection, liquid management, and marinating. It removes the air inside the chamber and the product. This way, the maximum vacuum is achieved for food preservation.

Internal Suction

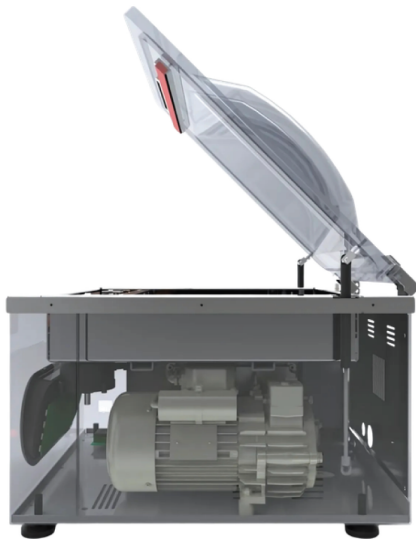

Ideal for professional catering, delicatessen, bar, packaging, beverage production, restaurants

Tabletop

Removes the air inside the chamber and the product, achieving the maximum vacuum for food preservation.

Programs

	% vacuum %	vacuum program seconds
Marinade ~~~~~		Liquid 💧



**DVA 50C - 2/50C
Trolleybus**



Bag sealing

Optional upon request



Inert gas system Built-in printer
Print speed 80mm/s Thermal paper 57x30mt x 12
LINERLESS paper Quick installation



Bag cutting



System that removes air from the chamber



Inclined surface
especially when the food contains liquids (e.g. marinated meats, cheeses in brine, sauces), so that the liquids "sit" low and do not run towards the sealing bar.

DVA PROFESSIONAL

DVA Professional vacuum series

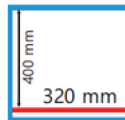

DVA 32

Welding bar 320mm

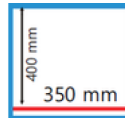

DVA 35

Welding bar 350mm

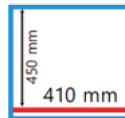

DVA 41

Welding bar 410mm

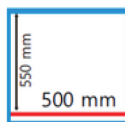

DVA 50 - DVA 50C

Welding bar 500mm

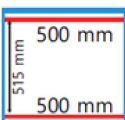

DVA 2/50 - DVA 2/50C

Welding bar 2/500mm

Model	Machine dimensions	Chamber dimension	Vacuum pump	Sealing bar	Inert gas (optional)	Power	Weight	Max bag
DVA 32	390X530x320 mm	330X400X175 mm	8 m ³ /h	320 mm	1	220 V-50-60 Hz 800 w	43kg	300x400 mm
DVA 35	422x530x323mm	360x400x175 mm	12 m ³ /h	350 mm	1	220 V-50-60 Hz 1200 w	45kg	350x400 mm
DVA 41	506x580x355 mm	417x464x180 mm	25 m ³ /h	410 mm	2	220 V-50-60 Hz 1500 w	55kg	400x450 mm
DVA 50	612x667x370 mm	512x550x200 mm	25 m ³ /h	510 mm	2	220 V-50-60 Hz 1500 w	75kg	500x550 mm
DVA 2/50	612x667x370 mm	512x550x200 mm	25 m ³ /h	2 x 510 mm	4	220 V-50-60 Hz 2300 w	75kg	500x550 mm
DVA 50C	612x667x900 mm	512x550x200 mm	25 m ³ /h	510 mm	2	220 V-50-60 Hz 1500 w	85kg	500x550 mm
DVA 2/50C	612x667x900 mm	512x550x200 mm	25 m ³ /h	2 x 510 mm	4	220 V-50-60 Hz 2300 w	85kg	500x550 mm

ST PROFESSIONAL

- Entirely made of AISI 304 stainless steel
- Control panel, waterproof and scratch-resistant.
- With **2 programs** designed for vacuum packaging of food and **9 programmable memories**.
- Pump dehumidification program.
- Removable glue sticks for easier cleaning, transparent plexiglass lid.
- The ST Professional series with functions such as program vacuum with time selection, liquid management and marinating, removes air from the inside of the chamber. In this way, with the ST series vacuum machines we achieve the maximum vacuum for product preservation.

Internal Suction

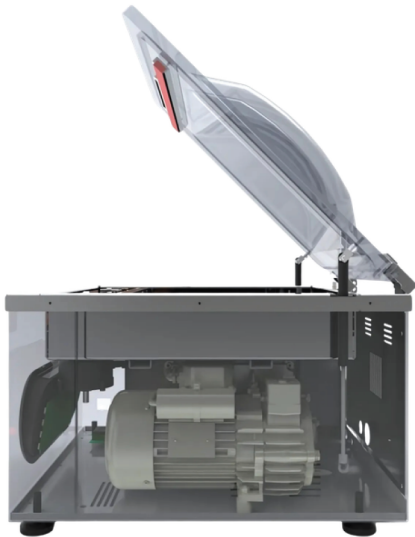

Ideal for professional catering, delicatessen, bar, packaging, beverage production, restaurants

Tabletop

Dehumidification with H2O pump

Programs

		vacuum program ⌚ seconds
Marinade ~~~~~		Liquid 💧



**ST 50C - 2/50C
Trolleybus**



Heat sealing bag



**Oxygen warning
21% >**

Optional upon request



Inert gas system Built-in



Bag cutting



System that removes air from the chamber



Inclined surface especially when the food has liquids to prevent them from running towards the sealing bar



ST Professional vacuum series

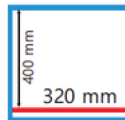

ST 32

Welding bar 320mm

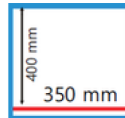

ST 35

Welding bar 350mm

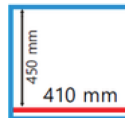

ST 41

Welding bar 410mm

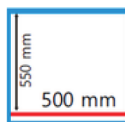

ST 50 - ST 50C

Welding bar 500mm

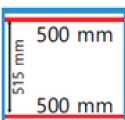

ST 2/50 - ST 2/50C

Welding bar 2/500mm

Model	Machine dimensions	Chamber dimension	Vacuum pump	Sealing bar	Inert gas (optional)	Power	Weight	Max bag
ST 32	390X530x320 mm	330X400X175 mm	8 m ³ /h	320 mm	1	220 V-50-60 Hz 800 w	43kg	300x400 mm
ST 35	422x530x323mm	360x400x175 mm	12 m ³ /h	350 mm	1	220 V-50-60 Hz 1200 w	45kg	350x400 mm
ST 41 *	506x580x355 mm	417x464x180 mm	25 m ³ /h	410 mm	2	220 V-50-60 Hz 1200 w	55kg	400x450 mm
ST 500	612x667x370 mm	512x550x200 mm	25 m ³ /h	510 mm	2	220 V-50-60 Hz 1500 w	75kg	500x550 mm
ST 2/50	612x667x370 mm	512x550x200 mm	25 m ³ /h	2 x 510 mm	4	220 V-50-60 Hz 2300 w	75kg	500x550 mm
ST 500C	612x667x900 mm	512x550x200 mm	25 m ³ /h	510 mm	2	220 V-50-60 Hz 1500 w	85kg	500x550 mm
ST 2/50C	612x667x900 mm	512x550x200 mm	25 m ³ /h	2 x 510 mm	4	220 V-50-60 Hz 2300 w	85kg	500x550 mm

* ST 410 with 12 m³/h and 1500 w pump

Vacuum Packaging Basin (skin)

HVT-TS tabletop vacuum packaging machine specially designed for disc packaging. It mainly consists of a frame, a film release mechanism (consisting of a film rack, a film rolling cylinder, and a film drive cylinder), and an upper and lower vacuum chamber.

1. 304 stainless steel construction
2. Electronic temperature control system
3. Simple and user-friendly operation
4. Molds can be customized according to customer requirements

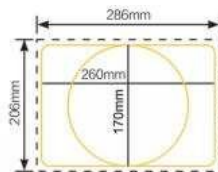

	HVT-240TS
Code	300.2000
Maximum disc size (mm)	286x206x45
Maximum roll film width	250
Maximum roll film diameter	150
Packaging speed	-
Vacuum pump	10m ³ /h
Power supply	220V/50Hz
Power	1150W
Chamber dimensions	288x208x58
Dimensions (mm)	500x370x435
Price	1800€





External suction table

Vacuum $\mu\epsilon$ LED display

- Small professional vacuum sealer
- Auto/manual operation
- Flexible and easy to use
- Comes with vacuum bags
- Use simple bags or cooking bags for sous vide

with one adhesive bar



V35e

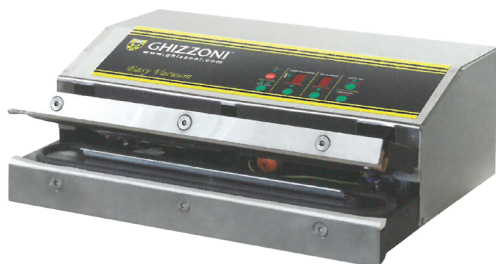

Code	107.0000
Power supply	230V/50Hz
Pump	10Lt/mm
Bonding length	350mm
Adhesive thickness	5mm
Dimensions	350x260x130
Weight	7Kg
Price	640 €

V40e

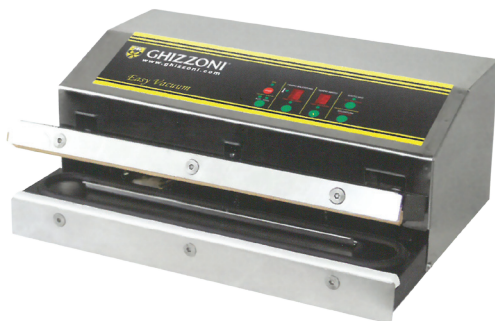

Code	107.0001
Power supply	230V/50Hz
Pump	40Lt/mm
Bonding length	400mm
Bonding width	5mm
Dimensions	400x260x140
Weight	8Kg
Price	700 €

V45e



Code	107.0002
Power supply	230V/50Hz
Pump	40Lt/mm
Bonding length	450mm
Bonding width	5mm
Dimensions	450x260x140
Weight	9Kg
Price	720 €

Vacuum

- Built-in roll storage
- Built-in cutter
- Built-in removable liquid storage box, catches overflow liquids.
- Unique Easy-Lock system.
- "SEAL TIME +" button to extend sealing time
- Marinating button, marinates quickly in a few minutes



Code	Model	Power supply	Power	Bonding length	Adhesive thick	Dimensions mm	Price
300.0122	V6100	230V/50Hz	150W	300mm	4mm	400*140*170	230€

VS200S Happy

Stainless steel vacuum pump, LED display, double pump, pulse button. With roll storage space and built-in cutter. Double sealing bar. Separate vacuum function for dry or wet foods. The double pump ensures more stable operation and faster evacuation speed. Pulse button to control the time and degree of evacuation. Optional motor speed (high/low). Prevents air leakage.

- LED display
- Dual pump
- Pulse button



Code	Model	Power supply	Power	Bonding length	Adhesive thick	Dimensions mm	Price
300.0121	VS200S	230V/50Hz	165W	320mm	2*3mm	420*530*400	210 €



†

With the **MX series**, your vacuum chamber machine will no longer be just a food preservation machine, but thanks to its innovative and intuitive software, you can create infusions or marinades in a short time, cold and controlling the entire process. Thanks to the liquid sensor, you can avoid annoying product leaks from the bag.



Key features

- High-strength 5" LCD touch screen
- 8GB micro SD memory
- USB port
- Temperature sensor port
- Removable sealing bar
- Wi-Fi & Bluetooth
- True Vac sensor
- Smart H2O liquid sensor
- Oil cleaning program



Software

- My recipes
- 24 programmable recipes
- Food preservation divided into 7 categories
- 7 marinating levels
- 3 infusion levels
- 6 category levels for vacuum packing food
- Backup creation via USB
- Smart icon
- Available in multiple languages



Specifications

Model	MX2	MX3	MX4
Code	103.0009		103.0011
Electrical voltages	220-50/60Hz		
Colors	Blue	-	stainless steel
Welding bar	Front	Front + side	2 side
Welding length	260	310 mm/360 mm	450mm
Liters	7L	15	24L
Dimensions of cover when open	322x473x513mm	420x192x693mm	544x658x762mm
Dimensions when closed	322x473x242.5mm	420x192x384mm	544x658x509mm
Chamber dimensions	270x149x179.5mm	329x386x120mm	466x456x212mm
VACUUM PUMP	4m3	8m3	16m3
Maximum power consumption power	0.4 A	0.8 A	1 front sealing rod 1 double sealing bar
Net weight	24	32	75
Price	€3,400		€6,000



H₂O SMART™



MX2 | Choose your color



MX2 dimensions

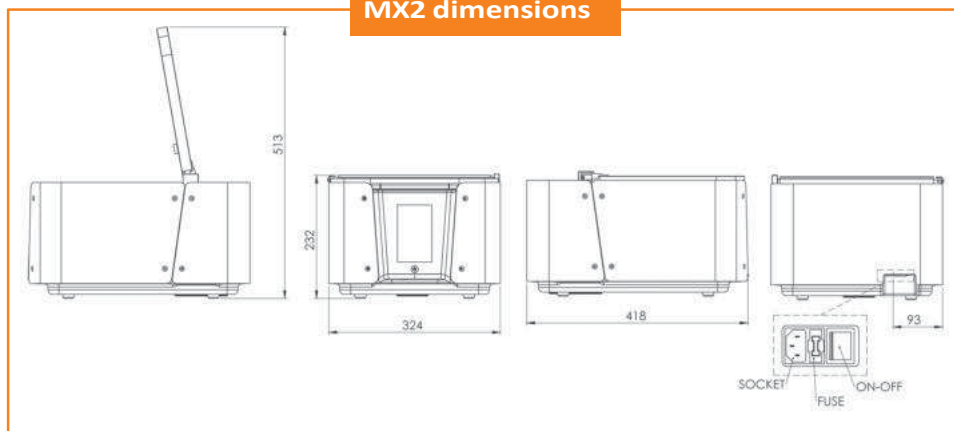

Preset programs at the touch of a button



Why choose itchoose

Innovation is what sets a business apart these days. more every Whatever you can think of, imagine the user wants to create, they can achieve it with the MX series from the Italian company MINIPACK. The ideas are many, the imagination is great, and the machine is an MX2-MX4.



†

- Stainless steel construction
- Easy to clean
- Protects the electronic parts from rust
- For all types of solid products
- Transparent lid for checking the filling.
- **The machine can print the expiration date on the bag.**
- For packaging meat, cold cuts, and cheese.



DZ-260/PD

DZ-300/PD
DZ-400/ZT



DZ-260/PD

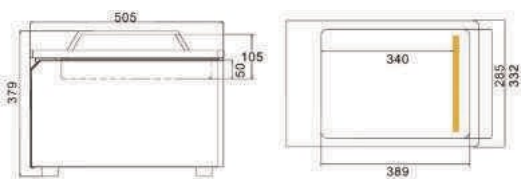

Code	031.0000
Power supply	230V/50Hz
Pump	14.4m ³ /h
Bonding length	250mm
Bonding thickness	5
Chamber height	105mm
Machine Dimensions	502*330*380
Weight	37.2Kg
Price	1,500€

DZ-300/PD

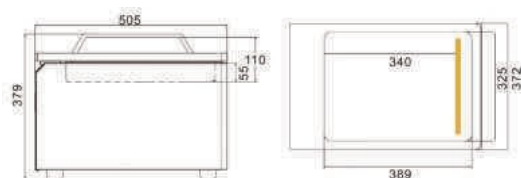

Code	031.0001
Power supply	230V/50Hz
Pump	14.4m ³ /h
Bonding length	300mm
Bonding thickness	50
Chamber height	110mm
Machine Dimensions	525*400*380
Weight	40Kg
Price	1,700€

DZ-400/ZT

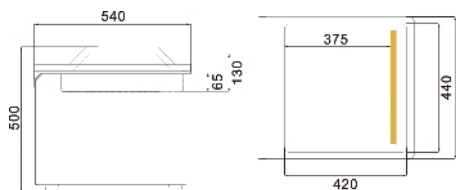

Code	031.0002
Power supply	230V/50Hz
Pump	20m ³ /h
Welding length	400mm
Bonding thickness	10
Chamber height	120mm
Machine dimensions	540*490*500
Weight	62.5Kg
Price	€2,100

†

- Stainless steel construction
- Easy to clean - Protects the electronic parts from rust
- For all types of solid products
- Transparent lid for checking the contents.
- The machine has the ability to print the expiration date on the bag. - For packaging meat, cold cuts, and cheese.



DZ-400/ZT20

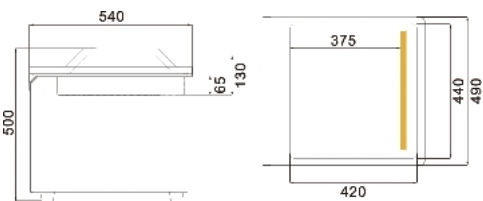

DZ-400/ZT20 available with gas

Code	031.0003
Power supply	230V/50Hz
Pump	20m ³ /h
Sealing length	400mm
Bonding thickness	10
Chamber height	200mm
Machine Dimensions	540*490*500
Weight	62.5Kg
Price	2,300€

DZ-450/ZT

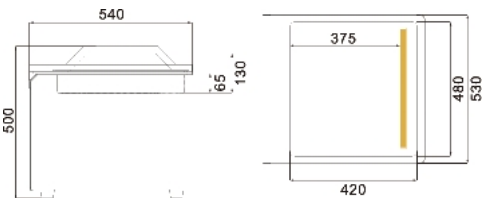

Code	031.0004
Power supply	230V/50Hz
Pump	20m ³ /h
Bonding length	450mm
Bonding Thickness	10
Chamber height	115mm
Machine Dimensions	540*490*500mm
Weight	70Kg
Price	2,300€

DZ-500/ZT

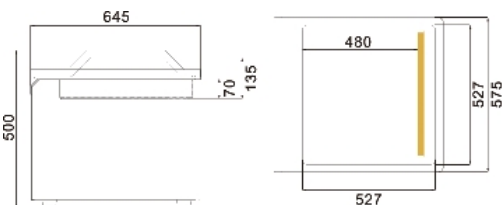

Code	031.0005
Power supply	230V/50Hz
Pump	20m ³ /h
Welding length	500mm
Bonding thickness	10
Chamber height	120mm
Machine dimensions	645*575*500
Weight	77Kg
Price	2,700€

Vacuum desktop

- Quickly and securely seals simple or cooking bags
- Deep tabletop vacuum
- Stainless steel construction
- LED display
- Ideal for packaging cold cuts/cheeses/meats



Specifications

DZ-300PJ

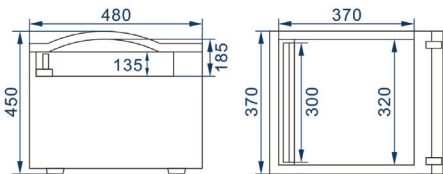

Code	300.0136
Power supply	220V/50Hz
Pump	10m ³ /h
Bonding length	370mm
Adhesive thickness	10mm
Dimensions	480*370*450mm
Price	1.600€

DZ-400G

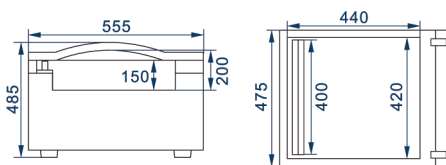

Code	300.0133
Power supply	220-240V 50/60Hz
Pump	20m ³ /h
Bonding length	400mm
Adhesive thickness	10mm
Dimensions	555*440*485
Price	1800€

DZ-450A

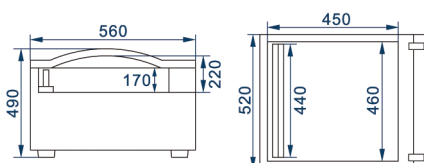

Code	300.0134
Power supply	220-240V 50/60Hz
Pump	20m ³ /h
Bonding length	450mm
Adhesive thickness	10mm
Dimensions	560*450*490
Price	2.100€

†



- Transparent lid for checking the packaging



Program

1. Vacuum
2. Soft vacuum
3. Marinating
4. External vacuum
5. Pump cleaning



Ideal for packaging

meat, olives, cold cuts, cheese, etc.

Control panel



Specifications

Model	HVC 210T	HVC 300T	DZ 400T	DZ 500T
Code	300.2001	300.2002	300.2003	300.2004
Power supply	230/50Hz	230/50Hz	230/50Hz	230/50Hz
Pump	4m3h	10m3h	20m3h	20m3h
Welding length	210	300	400	500
Welding thickness	5	5	5	5
Chamber dimensions	240*305*75	320*380*110	406*456*190	506*556*190
Net weight	-	-	-	-
Price	€1140	€1800	€2400	€3000

Vacuum tabletop *Internal Suction*



- Made entirely of AISI 304 stainless steel
- Transparent lid for checking the packaging
- Double sealing
- Digital control panel
- Easy disassembly of the sealing bar



Ideal for packaging meat, olives, cold cuts, cheese, etc.



Specifications



Model	VP-430	Gas	VP-580A
Code	109.0001		109.0002
Power	230/50Hz		230/50Hz
Colors	stainless steel		Stainless steel
Welding bar	Front		Front
Welding length	400		550mm
Welding thickness	3mm*2		3mm*2
Chamber dimensions	430*400*200		590*400*200
VACUUM PUMP	20m3h-OIL		20m3h-OIL
Price	4.400€		5,800€

Vacuum floor lite

- Stainless steel construction
- Fast, easy to use
- Electronic function display
- For all types of solid products
- Transparent lid for checking the packaging.
- The machine can print the expiration date on the bag.
- For packaging meat, olives, cold cuts, cheese, etc.



CE

DZ-400/2E

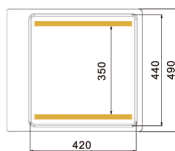
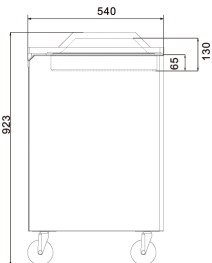

	Flat	Bowl	Gas Bowl
Model	DZ-400/2E	DZ-400/2E/20	DZ-400/2E/20
Code	031.0006	031.0007	031.0019
Power supply	230V/50Hz	230V/50Hz	230V/50Hz
Pump	20m ³ /h	20m ³ /h	20m ³ /h
Bonding length	400mm	400mm	400mm
Adhesive thickness	10mm	10mm	10mm
Height Chamber	160mm	200mm	200mm
Weight	70Kg	70Kg	70Kg
Price	2.200€	2.400€	2.800€

DZ-500/2E

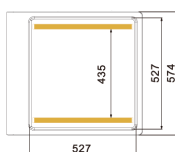
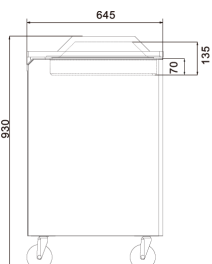

	Flat	Bowl	Gas Bowl
Model	DZ-500/2E	DZ-500/2E/20	DZ-500/2E/20
Code	031.0008	031.0009	031.0010
Power supply	230V/50Hz	230V/50Hz	230V/50Hz
Pump	20m ³ /h	20m ³ /h	20m ³ /h
Bonding length	500mm	500mm	500mm
Adhesive thickness	10mm	10mm	10mm
Height Chamber	160mm	200mm	200mm
Weight	97Kg	97Kg	97Kg
Price	2.600	2.800€	3.000€

Vacuum floor lite

- Stainless steel construction
- Fast, easy to use
- Electronic function display
- For all types of solid products
- Transparent lid for checking the packaging.
- The machine can print the expiration date on the bag.
- For packaging meat, olives, cold cuts, cheese, etc.



DZ-600/2E

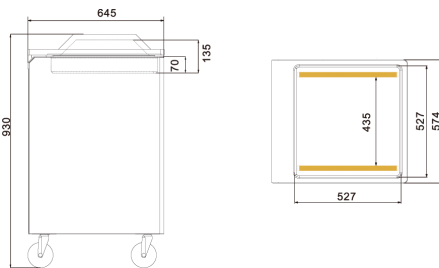

	Flat	Bowl	Gas Bowl
Model	DZ-600/2E	DZ-600/2E/20	DZ-600/2E/20
Code	031.0012	031.0013	031.0014
Power supply	380V/50Hz	380V/50Hz	380V/50Hz
Pump	40m ³ /h	40m ³ /h	40m ³ /h
Bonding length	600mm	2x600mm	600mm
Adhesive thickness	10mm	10mm	10mm
Height Chamber	160mm	200mm	200mm
Weight	151Kg	151Kg	151Kg
Price	3.700€	4.200€	4.400€

DZ-600E/20 Bowl

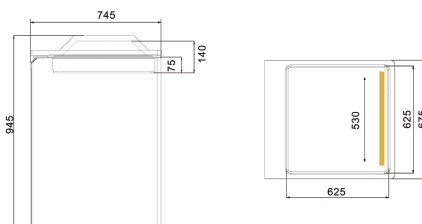

	Gas Bowl	
Model	DZ-600E/20	
Code	031.0016	031.00..
Power supply	380V/50Hz	380V/50Hz
Pump	40m ³ /h	40m ³ /h
Bonding length	600mm	600mm
Adhesive thickness	10mm	10mm
Height Chamber	200mm	200mm
Weight	151Kg	151Kg
Price	4.200€	4.400€

Double Chamber Vacuum

- Stainless steel construction
- Easy to clean
- For all types of solid products

 *Ideal for packaging meat, cold cuts, cheese, fish, nuts*



DZ-500/2SA

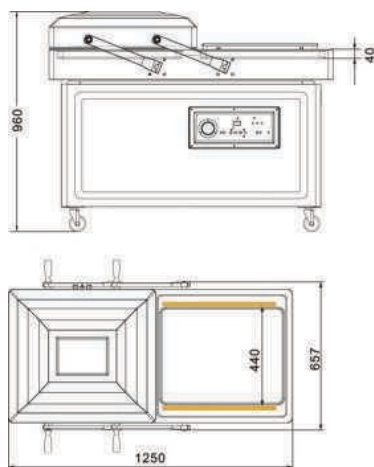

Code	031.0011
Power	380V/50Hz
Pump	40m ³ /h*2
Bonding length	4*500mm
Bonding thickness	10
Machine dimensions	1250*657*960mm
Weight	182 kg
Price	5,400€

Double Chamber Vacuum

DZ-600/2SA

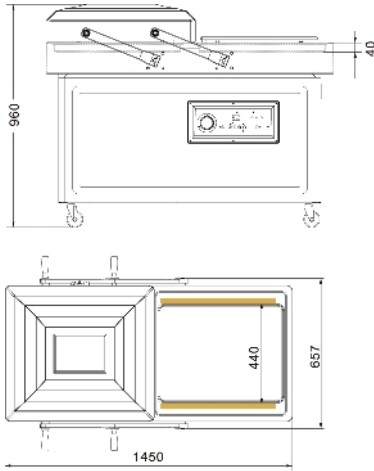

Code	031.0015
Power supply	380V/50Hz
Pump	40m ³ /h
Welding length	4*600mm
Bonding thickness	10
Machine dimensions	1450x660x960mm
Weight	215
Price	7,000€



DZ-700/2SB Deep

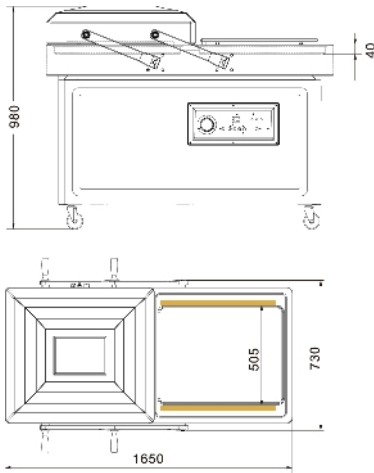

Code	031.0017
Power supply	380V/50Hz
Pump	40m ³ /h (63m ³ /h optional)
Bonding length	4*700mm
Bonding thickness	10
Machine dimensions	1730x815x1045mm
Weight	330
Price	8,000€



Double Chamber Vacuum

- Large vacuum packaging machine with two vertical sealing bars
- Stainless steel construction
- For all types of solid products
- With digital panel and volumetric electronic sensor for continuous vacuum control.



Ideal for packaging meat, cold cuts, cheese, fish, nuts



DZ-900/2L

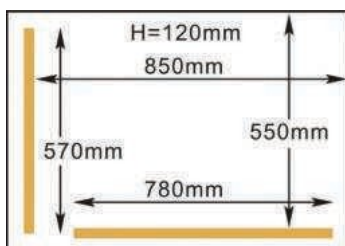

Code	031.0018
Power	380V/50Hz
Pump	40m ³ /h
Bonding length	570*780mm
Gluing thickness	10
Chamber dimensions	120mm/190m ³ /h
Machine dimensions	990x700x900mm
Weight	245
Price	7,800€

ICS Smooth Vacuum Bags

Ideal for cooking

For 1 hour at 80°C and for 30 minutes at 90°C For 2 hours at 70°C and for 15 minutes at 100°C



Description	Thickness	Dimensions	Price
ICS BAGS VACUUM BVS	95my	12*40	9,00 €
ICS BAGS VACUUM BVS	95my	12*45	9,00 €
ICS BAGS VACUUM BVS	95my	12*60	9,00 €
ICS BAGS VACUUM BVS	95my	14*22	9,00 €
ICS BAGS VACUUM BVS	95my	14*30	9,00 €
ICS BAGS VACUUM BVS	95my	14*45	9,00 €
ICS BAGS VACUUM BVS	95my	14*60	9,00 €
ICS BAGS VACUUM BVS	95my	15*20	9,00 €
ICS BAGS VACUUM BVS	95my	15*25	9,00 €
ICS BAGS VACUUM BVS	95my	15*30	9,00 €
ICS BAGS VACUUM BVS	95my	15*35	9,00 €
ICS BAGS VACUUM BVS	95my	16*30	9,00 €
ICS BAGS VACUUM BVS	95my	17*25	9,00 €
ICS BAGS VACUUM BVS	95my	18*20	9,00 €
ICS BAGS VACUUM BVS	95my	18*25	9,00 €
ICS BAGS VACUUM BVS	95my	18*28	9,00 €
ICS BAGS VACUUM BVS	95my	20*20	9,00 €
ICS BAGS VACUUM BVS	95my	20*25	9,00 €
ICS BAGS VACUUM BVS	95my	20*30	9,00 €
ICS BAGS VACUUM BVS	95my	20*35	9,00 €
ICS BAGS VACUUM BVS	95my	20*50	9,00 €
ICS BAGS VACUUM BVS	95my	20*40	9,00 €
ICS BAGS VACUUM BVS	95my	25*25	9,00 €
ICS BAGS VACUUM BVS	95my	25*30	9,00 €
ICS BAGS VACUUM BVS	95my	25*35	9,00 €
ICS BAGS VACUUM BVS	95my	25*40	9,00 €
ICS BAGS VACUUM BVS	95my	25*60	9,00 €
ICS BAGS VACUUM BVS	95my	26*65	9,00 €
ICS BAGS VACUUM BVS	95my	30*30	9,00 €
ICS BAGS VACUUM BVS	95my	30*40	9,00 €
ICS BAGS VACUUM BVS	95my	30*45	9,00 €
ICS BAGS VACUUM BVS	95my	30*50	9,00 €
ICS BAGS VACUUM BVS	95my	30*60	9,00 €
ICS BAGS VACUUM BVS	95my	30*70	9,00 €
ICS BAGS VACUUM BVS	95my	35*35	9,00 €
ICS BAGS VACUUM BVS	95my	35*50	9,00 €
ICS BAGS VACUUM BVS	95my	35*55	9,00 €
ICS BAGS VACUUM BVS	95my	38*40	9,00 €
ICS BAGS VACUUM BVS	95my	40*40	9,00 €
ICS BAGS VACUUM BVS	95my	40*50	9,00 €
ICS BAGS VACUUM BVS	95my	40*60	9,00 €
ICS BAGS VACUUM BVS	95my	45*50	9,00 €
ICS BAGS VACUUM BVS	95my	45*60	9,00 €
ICS BAGS VACUUM BVS	95my	50*60	9,00 €
ICS BAGS VACUUM BVS	95my	50*70	9,00 €
ICS BAGS VACUUM BVS	95my	60*40	9,00 €
ICS BAGS VACUUM BVS	95my	60*70	9,00 €
ICS BAGS VACUUM BVS	170my	24*47	13,00 €
ICS BAGS VACUUM BVS	170my	25*60	13,00 €
ICS BAGS VACUUM BVS	170my	25*35	13,00 €
ICS BAGS VACUUM BVS	170my	30*40	13,00 €
ICS BAGS VACUUM BVS	170my	30*50	13,00 €



ICS Vacuum Packaging Bags Smooth Gold & Black



ICS Vacuum Bags Black

Code	Description	Dimensions	Price
004.0209	ICS BAGS VACUUM BLACK/TRANSPARENT BVS	45*50	20,00 €
004.0204	ICS BAGS VACUUM BLACK/TRANSPARENT BVS	25*50	20,00 €
004.0201	ICS BAGS VACUUM BLACK/TRANSPARENT BVS	20*30	20,00 €
004.0200	ICS BAGS VACUUM BLACK/TRANSPARENT BVS	15*45	20,00 €
004.0202	ICS BAGS VACUUM BLACK/TRANSPARENT BVS	20*40	20,00 €
004.0208	ICS BAGS VACUUM BLACK/TRANSPARENT BVS	40*50	20,00 €
004.0207	ICS BAGS VACUUM BLACK/TRANSPARENT BVS	30*50	20,00 €
004.0203	ICS BAGS VACUUM BLACK/TRANSPARENT BVS	25*25	20,00 €
004.0210	ICS BAGS VACUUM BLACK/TRANSPARENT BVS	15*25	20,00 €
004.0206	ICS BAGS VACUUM BLACK/TRANSPARENT BVS	30*40	20,00 €
004.0205	ICS BAGS VACUUM BLACK/TRANSPARENT BVS	30*30	20,00 €
004.0211	ICS BAGS VACUUM BLACK/TRANSPARENT BVS	20*60	20,00 €

ICS Vacuum Bags Gold

Code	Description	Dimensions	Price
004.0109	ICS BAGS VACUUM GOLDEN/TRANSPARENT 95my BVS	20*45	20,00 €
004.0105	ICS BAGS VACUUM GOLDEN/TRANSPARENT 95my BVS	25*50	20,00 €
004.0102	ICS BAGS VACUUM GOLDEN/TRANSPARENT 95my BVS	20*25	20,00 €
004.0103	ICS BAGS VACUUM GOLDEN/TRANSPARENT 95my BVS	20*30	20,00 €
004.0101	ICS BAGS VACUUM GOLDEN/TRANSPARENT 95my BVS	15*45	20,00 €
004.0106	ICS BAGS VACUUM GOLDEN/TRANSPARENT 95my BVS	30*30	20,00 €
004.0100	ICS BAGS VACUUM ΧΡΥΣΕΣ /ΔΙΑΦΑΝΕΣ95my BVS	15*35	20,00 €
004.0108	ICS BAGS VACUUM GOLDEN/TRANSPARENT 95my BVS	40*50	20,00 €
004.0104	ICS BAGS VACUUM GOLDEN/TRANSPARENT 95my BVS	25*25	20,00 €
004.0107	ICS BAGS VACUUM GOLDEN/TRANSPARENT 95my BVS	30*40	20,00 €



ICS Vacuum Cooking Bags



Ideal for sous vide cooking

- For 4 hours at 95-100°C and for 30 minutes at 121°C

ICS Vacuum Cooking Bags Goffret

Code	Description	Dimensions	Price
	ICS BAGS VACUUM COOKING GOFFRETBVB	15*30	
003.0201	ICS BAGS VACUUM COOKING GOFFRETBVB	15*35	0,30 €
003.0202	ICS BAGS VACUUM COOKING GOFFRETBVB	20*30	0,40 €
003.0203	ICS BAGS VACUUM COOKING GOFFRETBVB	20*40	0,45 €
003.0205	ICS BAGS VACUUM COOKING GOFFRETBVB	30*40	0,60 €
003.0200	ICS BAGS VACUUM COOKING GOFFRETBVB	15*20	0,20 €
003.0204	ICS BAGS VACUUM COOKING GOFFRETBVB	25*35	0,50 €



ICS Smooth Vacuum Cooking Bags

Code	Description	Dimensions	Price
003.0400	ICS BAGS VACUUM COOKING SMOOTH BVB	15*20	0,16 €
003.0401	ICS BAGS VACUUM COOKING SMOOTH BVB	15*25	0,20 €
003.0402	ICS BAGS VACUUM COOKING SMOOTH BVB	15*30	0,24 €
003.0403	ICS BAGS VACUUM COOKING SMOOTH BVB	20*30	0,26 €
003.0404	ICS BAGS VACUUM COOKING SMOOTH BVB	20*40	0,26 €
003.0405	ICS BAGS VACUUM COOKING SMOOTH BVB	25*35	0,36 €
003.0406	ICS BAGS VACUUM COOKING SMOOTH BVB	30*40	0,50 €
003.0407	ICS BAGS VACUUM COOKING SMOOTH BVB	30*45	0,50 €
003.0408	ICS BAGS VACUUM COOKING SMOOTH BVB	30*50	0,56 €
003.0409	ICS BAGS VACUUM COOKING SMOOTH BVB	35*50	0,62 €
003.0410	ICS BAGS VACUUM COOKING SMOOTH BVB	40*45	0,62 €



ICS Black Vacuum Bags Goffret

ICS Black Vacuum Bags

Code	Description	Dimensions	Price
004.0502	ICS BAGS VACUUM GOFFRET/BLACK 90my BVS	15*40	0,28 €
004.0501	ICS BAGS VACUUM GOFFRET/BLACK 90my BVS	20*30	0,30 €
004.0503	ICS BAGS VACUUM GOFFRET/BLACK 90my BVS	25*35	0,40 €
004.0500	ICS BAGS VACUUM GOFFRET/BLACK 90my BVS	30*40	0,46 €

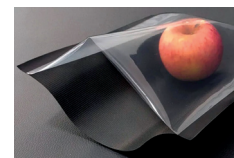

ICS Roll Goffret Black

Code	Description	Dimensions	Price
004.0504	ICS ROLL GOFFRET/BLACK BVS	20*6 measures	12,00 €
004.0505	ICS ROLL GOFFRET/BLACK BVS	28*6 measures	15,00 €
004.0506	ICS ROLL GOFFRET/BLACK BVS	30*6 measures	16,00 €
004.0507	ICS ROLL GOFFRET/BLACK BVS	40*6 measures	18,00 €

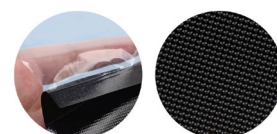

ICS Vacuum Bags Goffret



Ideal for cooking

For 1 hour at 80°C and for 30 minutes at 90°C

For 2 hours at 70°C and for 15 minutes at 100°C

Code	Description	Dimensions	Price
003.0000	ICS ROLL GOFFRET BVB	20*6	6,00 €
003.0001	ICS ROLL GOFFRET BVB	30*6	8,00 €
003.0002	ICS ROLL GOFFRET BVB	40*6	12,00 €
004.0406	ICS BAGS VACUUM GOFFRET BVS	16*23	0,08 €
004.0407	ICS BAGS VACUUM GOFFRET BVS	20*30	0,14 €
004.0408	ICS BAGS VACUUM GOFFRET BVS	20*40	0,16 €
004.0409	ICS BAGS VACUUM GOFFRET BVS	25*35	0,18 €
004.0410	ICS BAGS VACUUM GOFFRET BVS	30*40	0,24 €
003.0100	ICS BAGS VACUUM GOFFRET BVB	15*30	0,14 €
003.0101	ICS BAGS VACUUM GOFFRET BVB	15*35	0,14 €
003.0121	ICS BAGS VACUUM GOFFRET BVB	15*40	0,20 €
003.0102	ICS BAGS VACUUM GOFFRET BVB	15*60	0,24 €
003.0103	ICS BAGS VACUUM GOFFRET BVB	16*23	0,14 €
003.0104	ICS BAGS VACUUM GOFFRET BVB	18*30	0,16 €
003.0105	ICS BAGS VACUUM GOFFRET BVB	20*30	0,18 €
003.0106	ICS BAGS VACUUM GOFFRET BVB	20*35	0,22 €
003.0107	ICS BAGS VACUUM GOFFRET BVB	20*40	0,28 €
003.0108	ICS BAGS VACUUM GOFFRET BVB	20*60	0,32 €
003.0122	ICS BAGS VACUUM GOFFRET BVB	25*25	0,24 €
003.0109	ICS BAGS VACUUM GOFFRET BVB	25*35	0,28 €
003.0110	ICS BAGS VACUUM GOFFRET BVB	25*40	0,30 €
003.0123	ICS BAGS VACUUM GOFFRET BVB	25*50	0,34 €
003.0111	ICS BAGS VACUUM GOFFRET BVB	25*60	0,42 €
003.0112	ICS BAGS VACUUM GOFFRET BVB	25*70	0,46 €
003.0113	ICS BAGS VACUUM GOFFRET BVB	30*40	0,34 €
003.0114	ICS BAGS VACUUM GOFFRET BVB	30*50	0,38 €
003.0115	ICS BAGS VACUUM GOFFRET BVB	30*60	0,44 €
003.0116	ICS BAGS VACUUM GOFFRET BVB	35*45	0,38 €
003.0117	ICS BAGS VACUUM GOFFRET BVB	40*30	0,36 €
003.0118	ICS BAGS VACUUM GOFFRET BVB	40*50	0,44 €
003.0124	ICS BAGS VACUUM GOFFRET BVB	40*60	0,50 €
003.0119	ICS BAGS VACUUM GOFFRET BVB	50*60	0,64 €
003.0120	ICS BAGS VACUUM GOFFRET BVB	50*80	0,86 €

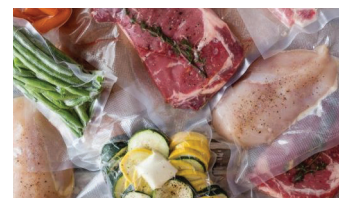

... **REDUCE BAKING TIME BY UP TO 50%**

... **ENERGY SAVINGS OF UP TO 20%**



Vacuum Bags for Baking in the Oven

Specially designed to withstand high temperatures, while preserving the flavor and nutrients of the food.

Made from heat-resistant materials without harmful substances (such as BPA), they allow cooking directly in the oven.



Ideal for grilling meat, fish or vegetables, they offer absolute safety, cleanliness and deliciousness, without loss of moisture or flavor.

▶ Watch the VIDEO to see how to bake in the oven, quickly and easily!



SCAN HERE

For baking in convection ovens and domestic air ovens.

SAVE TIME!



the bag should be filled as much as possible, leaving room only for gluing



in a convection professional oven up to 180°C and up to 2.5h in a domestic oven air baking, up to 210°C and up to 2.5h

Code	Bag Dimension	Suggested Use	Ideal for
004.0600	20x30 cm	Small portions	- 1 chicken fillet or brisket - Small fish (e.g. anchovy) - Vegetables for 1 person
004.0601	25x35 cm	Medium portions	- 2-3 steaks or fillets - Sea bream or sea bass - Amount of vegetables for a family table - menu for 2 people
004.0602	30x40 cm	Family portions / Whole pieces	- Whole chicken - Large piece of beef/pork - Whole salmon - menu for 4+ people
004.0603	35x45 cm	Large pieces of meat or multiple servings	- Pork or beef roll - Whole duck or large turkey - Baking for family dinners or events - Preparing large quantities sous vide
004.0604	40x50 cm	Professional use / very large meals	- Large turkey, pork leg or lamb - Catering cooking - Combination meals (meat + vegetables) - Storage & baking in large batches



TIPS! ... the bag

- to be placed on a baking sheet for clean baking
- be filled to the brim

The bag opens on its own after about 15-20 minutes to release the internal pressure.

- not for use on grill
- not for use in gas ovens and microwaves.
- not placed on the bottom of the oven

Box sealing device

This equipment is widely used in packaging fresh meat, cooked meat products, fast food, baked goods, rice noodles, cheese, soy products, aquatic products, poultry, fruits and vegetables, etc.

1. 304 stainless steel construction
2. The mold can be quickly replaced
3. Electronic temperature control system
4. Simple and user-friendly operation
5. Molds can be customized according to customer requirements

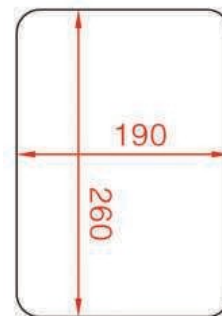

	DS-4
Code	300.2007
Maximum disc size (mm)	260 x 190 x 100
Maximum roll film width	180
Maximum roll film diameter	160
Packaging speed	7-8 times/minute
Power supply	230V/50Hz
Power	0.6Kw
Dimensions (mm)	650x296x260
Weight	17
Price	1600€

Handheld



- It has a built-in protection system for safety
- The bonding time is adjustable from 0-3 seconds.
- Bonding is automatic with a visual end indicator
- Ideal for supermarkets, coffee shops, packaging companies

Model	R300	R400
Code	020.065	020.0653
Power	230V/50Hz	230V/50Hz
Welding length	300mm	400mm
Bonding thickness	2mm	2mm
Price	200€	270€



Handheld



- Handheld heat sealer manufactured in China
- Painted
- Sturdy construction
- The sealing time is adjusted according to the bag

Model	X200	X300	X400	X500
Code	300.0410	300.0411	300.0412	300.0414
Power supply	230V/50Hz	230V/50Hz	230V/50Hz	230V/50Hz
Welding length	200	300	400	500
Bonding thickness	2	2	2	2
Price	90€	100€	€140	180€



Foot



- Heat-sealed foot
- Heavy-duty construction
- Sealing time adjustable from 0" to 5"
- Ideal for supermarkets, coffee shops, packaging companies

Model	PFS 450JT	PFS 600JT
Code	300.0413	300.0415
Power	1000W	1800W
Power	230V/50Hz	230V/50Hz
Welding length	450	600
Welding thickness	5	5
Weight	21	24.5 kg
Price	500€	€520



HW45 Food Wrap Machine

- Easy and quick packaging
- Stainless steel cover
- Cutting system on both sides
- Easy film replacement
- Designed for food packaging such as meat, cheese, pasta, fresh fruit, and vegetables

Model	HW45
Code	020.0657
Bonding length	450mm
Diameter film	110mm
Dimension	560x173mm
Price	360€

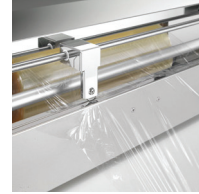

CE

45K Food Wrap Machine

- Made entirely of stainless steel.
- Semi-automatic operation
- Designed for food packaging such as meat, cheese, pasta, fresh fruit, and vegetables

Model	45K
Code	020.0655
Power supply	230V/50Hz
Bonding length	450mm
Dimension plato	380x120mm
Dimension	470x590mm
Price	400€

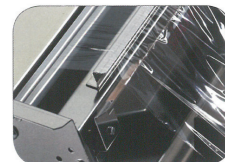

CE

50K M2 Food Wrap Machine

- Designed for food packaging such as meat, cheese, pasta, fresh fruit, and vegetables
- Made entirely of stainless steel
- Anodized aluminum rods

Model	50K M2
Code	020.0656
Power supply	230V/50Hz
Bonding length	500mm
Dimension	590x290mm
Weight	14Kg
Price	680€



CE

Food Wrapping Machine

- Stainless steel construction
- Designed for food packaging such as meat, cheese, pasta, fresh fruit, and vegetables



IWM-550



IWM-450



Code	Model	Power supply	Power	Power μαχαιριού	Power θερμότητας	Ευρος θερμοκρασίας	Μήκος συγκόλλησης	Price
300.0723	IWM-450	230V/50Hz	330W	80W	250W	50°C-160°C	450mm	170€
300.0722	IWM-550	230V/50Hz	400W	100W	300W	50°C-160°C	550mm	300€

Open Metal Bag Sealer

- Bag sealing device
- Easy to use
- Ideal for bakeries, fruit shops, and supermarkets

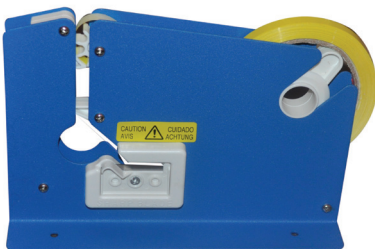

300.0401	Metal bag sealer inox	30 €
300.0400	Metal bag sealer blue	24 €
085.9540	Open Metal bag sealer	26 €
300.0403	scotch tape red	2,50 €
300.0404	scotch tape blue	2,50 €

Food Wrapping Machine

- Stainless steel film device
- Length: 60cm
- Accepts up to 55cm film up to 1500 meters



101.0055	200 €
----------	-------

Membrane Devices

KY-450 (closed type)

- Manual membrane device
- Made entirely of stainless steel
- Easy film replacement
- Designed for food packaging such as meat, cheese, pasta, fresh fruit, and vegetables

Model	KY-450
Code	300.0727
Bonding length	450
Film diameter	110mm
Dimensions	550x250x175mm
Price	140€



CE

KY-500

- Made of carbon steel
- Designed for packaging food products such as meat, cheese, pasta, fresh fruit, and vegetables



Model	KY-500
Code	300.0728
Bonding length	500
Dimensions	585x200x120mm
Price	100€

CE

Shrink Machine

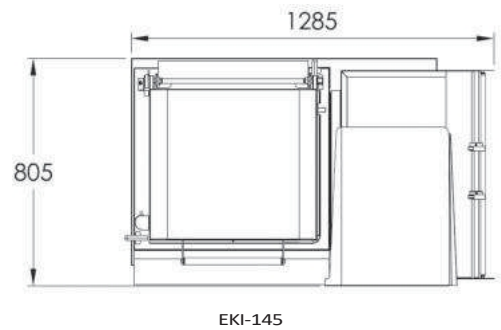
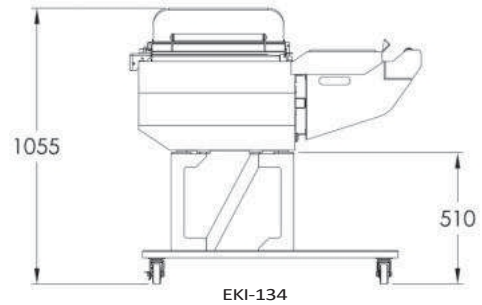

Features

- Digital control panel for easy operation
- Digital control panel for clearing error message updates
- Fixed air hole design for accuracy and precision of the air hole
- Packaging chamber with special coating, very convenient clean surface
- Effective air cooling system that allows for long working hours



► Control Panel



	EKI-134	EKI-145
Code	300.0725	300.0726
Power supply	230V/50Hz 1Phase	230V/50Hz 1Phase
Maximum consumption	3.2 kW	3.77 kW
Power consumption	1.3-1.9 kW	1.6-2.3 kW
Sealing dimensions	460 x 335 mm	550 x 415 mm
Maximum package height	210	300mm
Maximum film dimensions	400 x ø250mm	600 x ø250mm
Price	€3400	€4400



Product
display

Priority
System

Ideal for butcher shops, supermarkets, and food stores



U

- Special display disk for the promotion of products.
- Material: PS

Code	102.0071
Dimensions	500*440*80H
Price	100€



Compliant with EU regulations

U

- Special display disk for the promotion of products
- Material: PS

Code	102.0070
Dimensions	810*440*75H
Price	130€



Compliant with EU regulations

)

- Material: PMMA

Code	102.0043	102.0042
Dimensions	400*250*60H	400*250*100H
Price	28€	30€



In accordance with EU regulations.

Display plexus for food promotion

- Material: PMMA

Ideal for butchers, supermarkets, and food stores

Code	102,0036
Dimensions	385*245
Price	10€

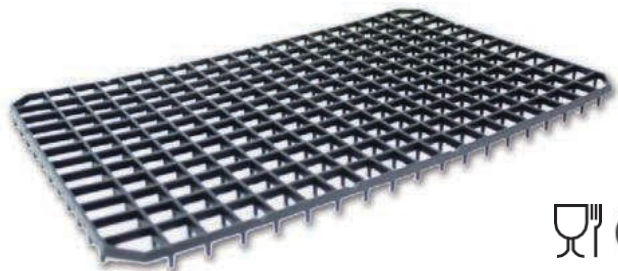

In accordance with EU regulations.

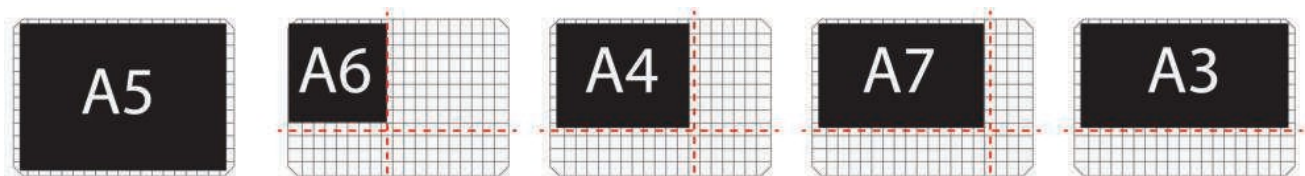

PMMA discs for product promotion



▶ Tray A2

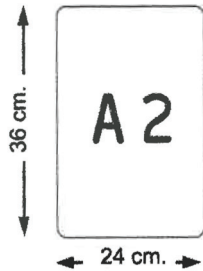

H 8,5 cm.

▶ 102.0058 D:36 x 24 x **8,5 H** cm ▶ 16 €

H 5 cm.

▶ 102.0057 D:36 x 24 x **5 H** cm ▶ 15 €

H 3,5 cm.

▶ 102.0056 D:36 x 24 x **3,5 H** cm ▶ 14 €

▶ Tray A3

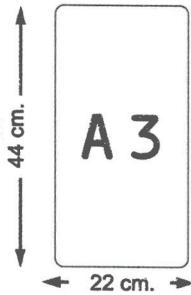

H 8,5 cm

▶ 102.0027 D:44 x 22 x **8,5 H** cm ▶ 15,50 €

H 5 cm

▶ 102.0028 D:44 x 22 x **5 H** cm ▶ 15,50 €

H 3,5 cm

▶ 102.0029 D:44 x 22 x **3,5 H** cm ▶ 15,50 €

H 2,6 cm

▶ 102.0030 D:44 x 22 x **2,6 H** cm ▶ 14,50 €

▶ Tray A4

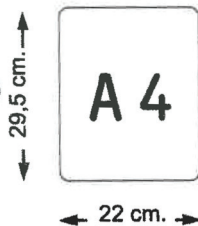

H 8,5 cm.

▶ 102.0014 D:29,5 x 22 x **8,5H**cm ▶ 14 €

H 5 cm.

▶ 102.0015 D:29,5 x 22 x **5 H**cm ▶ 12 €

H 3,5 cm.

▶ 102.0016 D:29,5 x 22 x **3,5H**cm ▶ 10 €

H 2,6 cm.

▶ 102.0017 D:29,5 x 22 x **2,6H**cm ▶ 10 €

▶ Tray A5



H 10 cm.

▶ 102.0022 D:44 x 29 x **10 H** cm ▶ 21 €

H 8,5 cm.

▶ 102.0023 D:44 x 29 x **8,5 H** cm ▶ 19 €

H 5 cm.

▶ 102.0024 D:44 x 29 x **5 H** cm ▶ 15,50€

H 3,5 cm.

▶ 102.0025 D:44 x 29 x **3,5 H** cm ▶ 15,50€

H 2,6 cm.

▶ 102.0026 D:44 x 29 x **2,6 H** cm ▶ 14,50€

▶ Tray A7

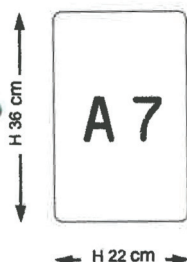

H 8,5 cm

▶ 102.0018 D:36 x 22 x **8,5 H** cm ▶ 18 €

H 5 cm

▶ 102.0019 D:36 x 22 x **5 H** cm ▶ 17 €

H 3,5 cm

▶ D:36 x 22 x **3,5 H** cm ▶ 17 €

H 2,6 cm

▶ 102.0021 D:36 x 22 x **2,6 H** cm ▶ 15,50 €

PMMA trays for product promotion



▶ Tray B3

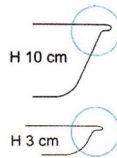

▶ 102.0081 D:40 x 30 x **10 H** cm ▶ 32,00 €

▶ 102.0080 D:40 x 30 x **3 H** cm ▶ 24,00 €

▶ Tray B2

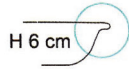
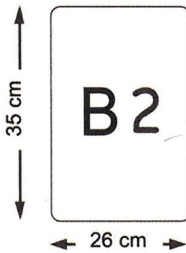

▶ 102.0082 D:35 x 26 x **6 H** cm ▶ 28,00 €

▶ Tray C1

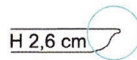
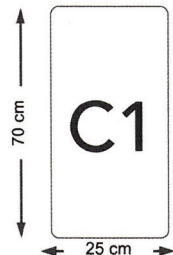

▶ 102.0075 D:70 x 25 x **2,6 H** cm ▶ 44,00 €

▶ Tray H

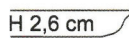
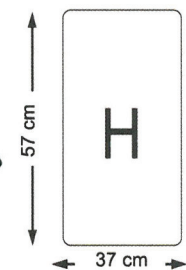

▶ 102.0076 D:57 x 37 x **2,6 H** cm ▶ 48,00 €

▶ Tray L

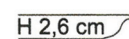
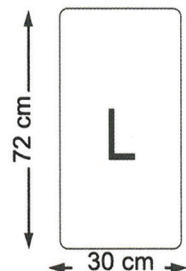

▶ 102.0077 D:72 x 30 x **2,6 H** cm ▶



Transparent tray cover

Acrylic cover transparent for trays in various dimensions. Lid with double opening. Material PMMA thickness 5 mm.

▶ Tray cover A3

▶ 102.0031 D:44 x 22 cm ▶ 35 €

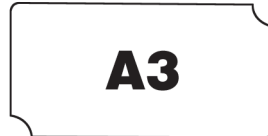

▶ Tray cover A4

▶ 102.0032 D:29,5 x 22 cm ▶ 34 €



▶ Tray cover A5

▶ 102.0033 D:44 x 29 cm ▶ 44 €

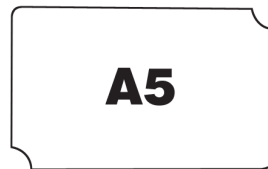

▶ Tray cover A7

▶ 102.0035 D:36 x 22 cm ▶ 33 €

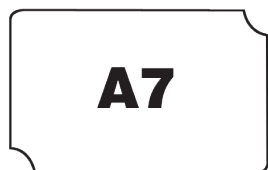

▶ Tray cover B3

▶ [redacted] D:35 x 26 cm ▶ €



Supermarket shopping baskets

- Available in red, blue, green
- Stackable for space saving
- Complies with EU regulations



	Blue	Green	Red
Code	102.0061	102.0062	102.0060
Liters	21Lt	21Lt	21Lt
Price	24€	24€	24€

	Blue	Green	Red
Code	102.0063	102.0064	102.0065
Liters	27Lt	27Lt	27Lt
Price	30€	30€	30€

Ideal for supermarkets and food stores

Hand-held supermarket trolley

- Available in red, blue, green
- Very modern design
- Stacks in dozens to save space
- Complies with EU regulations

Ideal for supermarkets and food stores



	Blue	Yellow	Red
Code	102.0066	102.0067	102.0068
Liters	64Lt	64Lt	64Lt
Dimensions	530*500*940mm	530*500*940	530*500*940mm
Price	45€	45€	45€





Open bases, small support

	White	Black	Transparent
Code	085.9412	085.9407	085.9418
Dimensions	10cm	10	5cm
Price	2.20	€2.20	€

The label is not included in the package.



Open bases large support

	White	Black	Transparent
Code	085.9417	085.9408	085.9409
Dimensions	10cm	15	10
Price	2.80	€3.40	€2.20

The label is not included in the package.

OPEN Labels for window decoration



Labels with your company name



Code	Description	Dimensions	Price
085.9404	Butcher's shop	8x12cm	0.90
085.9410	bakery	8x12cm	0.90
085.9411	black with white border	7x10cm	0.90
085.9421	black with wood border	7x10cm	0.90

Prices do not include VAT. Prices are subject to change without notice.
The company is not responsible for any typographical errors.

OPEN MANTALAKI



Code	085.9420
Description	transparent 100mm
Price	1.80

The label is not included in the package

OPEN MANTALAKI



Code	085.9419
Description	black 100mm
Price	1.80

The label is not included in the package.

OPEN INOX NAIL



	White	Black
Code	085.9402	085.9400
Description	stain less	stain less
Price	1.60	1.60

OPEN PLASTIC NAIL



	White	Black
Code	085.9416	085.9401
Description	plastic	plastic
Price	1.20	1.20

OPEN *Stainless steel* corner base



	White	Black
Code	085.9414	085.9415
Dimensions	15	10cm
Price	5	5

OPEN clip base



Code	085.9422
Description	black
Price	1.60

Open supports

			
Code	085.9403	085.9413	085.9406
Dimension	small	small	large
Price	0.50	€0.50	1.20

OPEN Corner nail



Code	085.9403
Description	black
Price	0.8

Easyturn Priority System



Kit includes

Code 313.7900 MD2: 2-

digit display

TX: 433.92 MHz wireless remote control.

DISPENSER: Priority paper dispenser **TKS2000:** 2,000

priority tickets **CART:** Installation instructions

Price €310

MD2



Features

Code 313

2-digit LED display. Power supply 230V/50Hz

Made of durable plastic and aluminum, with a wall mount

It has an audible alarm, flashing digits, and can be connected to more than one screen to show the same priority number

Price €240

TX



Features

Code 313.7901 Wireless RF

433.92 MHz Range up to 20m.

Features

a red button to change the priority number and an LED to confirm the command to the 2-digit display.

Price €40

Dispenser



Features

Code 313.7904 red

Code 313.7905 yellow Priority paper dispenser with floor stand or wall mount.

Price €40

TKS 2000



Features

Priority paper in a roll of 2000 labels.

313.7909 red, 313.7911 white,

313.7915 green, 313.7907 yellow,

313.7913 blue.

Price €3.40

Cart



Features

Label with instructions regarding priority paper.



Customer

Two-digit display with 120 mm high characters 28 very bright red LEDs Operating temperature +5°/+45°C
 Power supply/consumption 230V/50Hz / 5W
 Master/slave function with button
 Buzzer with different sound (set by the control panel)
 For butchers, supermarkets, and busy stores Available in white or black
Price €250



Triple-sided customer display

Two-digit display with 120mm high letters 28 bright red LEDs Operating temperature +5°/+45°C
 Power supply/consumption 230V/50Hz / 5W
 Master/slave function with button
 Buzzer with different sound (set by the control panel)
 For butchers, supermarkets, and shops with heavy workloads Available in white or black
Price €800 with base

Peripheral

Speaker



Speaker to announce loudly when changing to the next number

Price upon request

Dispenser



Dispenser for priority number Available in green, red, and yellow

Price €30

Dispenser



The available colors are: green, red, blue, white, yellow. They are numbered cards, with circular numbering from 1 to 99, with a total of 2000 tickets. **Price €2.00/roll**

Remote control

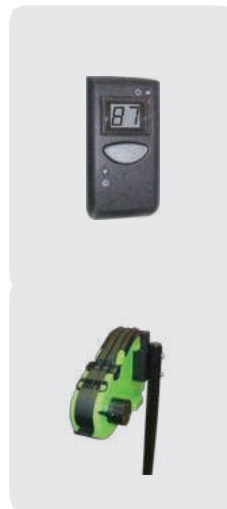

Code

Remote control with LED VT-2 Decreasing countdown display Audible message selection Message volume adjustment **Price €55**

Support column

Code

Dispenser support column

Price €40



Electronic label scales

Uni 3 L2

Retail scale with label printer - paper tape

Description

Alphanumeric green backlit LCD display with scrolling advertising message. The high-quality backlit display ensures optimal brightness and readability for all operators. An expandable database is available for storing all product information and transaction details. High-speed, high-quality label and receipt printing thanks to easily configurable preset functions.

 *Ideal for use in wholesale stores, butcher shops, grocery stores, and supermarkets.*



Ministry of Development and Competitiveness
Circular No. DPP-281/2015

	UNI3 L2	UNI3 L2-P	UNI3 L2-H
Display	2-line alphanumeric green backlit LCD with promotional message		
Keyboard	184 direct keys (bottom keyboard)	184 direct keys (Keyboard up)	184 direct keys (Keyboard up)
Data memory	6,000 programmable standard PLU items		
Weighing capability	6kg/2g, 15kg/5g, 30kg/10g		
Scale power supply	AC 100-240V, 50/60Hz		
Scale connections	PC connection, Ethernet 10/100		
Print speed	100 mm/sec		
Label printing	Barcode, production/expiration date, packaging date, brand name, description, ingredients, logo. Label configuration according to customer needs.		
Consumable size	Print width: 56mm, Roll diameter 90mm. Inner diameter 40mm. Width: 38mm-64mm. Length: 30mm-175mm		
Dimensions	410x437x153mm	410x500x570mm	420x146x319mm

Code	Model	Price
700.0130	UNI 3 L2 without stand, 15Kg	1.600 €
700.0131	UNI 3 L2 without stand, 30Kg	1.600 €
700.0137	UNI 3 L2-P 30K 4MB (L/R) with stand	1.750 €
700.0136	UNI 3 L2-P with stand 30Kg	1.700 €
700.0140	UNI 3 L2-H hanging bar 15Kg	2.000 €

Electronic label scales

PA-10e / PA-15

Description

- Label scale with printer featuring a cassette for easy replacement of paper/labels
- Built-in operating system TOS II (LINUX)
- Image/video advertising on the customer display



 *Ideal for bakeries, supermarkets, etc.*

Ports:

3*USB2.0, 1*USB2.0 (OTG)
2*RS-232, 1*RJ45 for Ethernet
1*RJ11, WIFI



Capacitive touch screen

**Ministry of Development and Competitiveness
Circular No. DPP-435/2021**

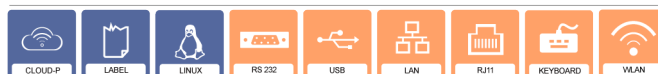

	PA-10e	PA-15
Code	700.0013	700.0010
Model	PA-10e-30K-MR	PA-15-30K-MR
Operator display	10.1" color touchscreen	15" color touchscreen
Customer display	10.1" color display	15" color display
CPU	ARM CORTEX A17 Quad core	
Memory	RAM 2 GB, Flash 16 GB	
Resolution	1280x800	1366x768
Paper width	60mm (max)	
Print speed	100mm/s	
Print width	56x180mm (max)	
Voltage	280x385mm	
Function	-10°C~40°C	
Power supply	AC100 ~ 240V 50/60Hz	
Weighing capacity	15Kg/30Kg sub. 5g/10g	
Price	2500 €	3200 €

Electronic label scales

ILS 1100

Description

- Ability to update the software online
- Printing on thermal labels and thermal paper for X-type reports
- Printing of 1D and 2D barcodes
- Thermal labels in various lengths
- Item lookup by code
- Real-time price and data updates
- Printing with 90° or 270° rotation
- Supports sale periods
- Multiple settings
- **Cassette-style printer** for easy label paper replacement



Ideal for supermarkets, butcher shops, bakeries, fishmongers, fruit and vegetable shops, delicatessens, and nut shops (packaging facilities)



ΥΠ. ΑΝΑΠ. ΔΠΠ 1417/2016

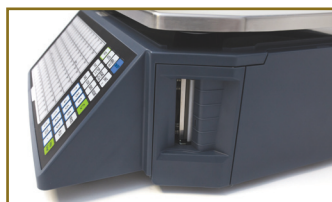

Features

Display	2-line 256x32 dot matrix LCD with scrolling promotional message
Keyboard	140-key keyboard with 224 memory slots (112x2 slots)
Min. print resolution	5g
Data memory	10,000 PLUs (codes)
Print speed	80mm/s
PC connection	Ethernet 10/100
Power supply	AC 100–240 V, 50/60 Hz
Dimensions	W437 x D372 x H523 mm • Base: 355 x 275 mm
Thermal roll size	Width: 30–60 mm, Maximum outer diameter: 100 mm Maximum inner diameter: 40 mm

Code	Model	Weighing capacity	Price
700.0101	ILS-1100 BNSL	30Kg sub.10g	960 €



Electronic scales with calculation Prices

G325 Battery- Electricity

Description

The Price G-325 calculating scale can be connected to a computer, cash register, POS system, and cash drawer. It supports data transmission/reception and updates, as well as RS-232 connectivity and communication protocols, with the option to upgrade via a computer. EAN programming, EPOS protocol. Energy savings through programmable backlight activation and deactivation and automatic power-off. Displays Weight, Price/kg, and total. Flat weighing surface made of stainless steel.

- Backlit LCD display with 3 operator and customer indicators
- 32-key keypad with 9 visible memory slots
- DC 6V-10A battery power supply & AC power cord
- Battery life: 100 hours without backlight (rechargeable)
- Dimensions: 295x225mm
- RS-232 interface, multi-protocol
(Connection to cash register)

Ideal for butcher shops, bakeries, fishmongers, fruit and vegetable shops, and stores selling deli meats and nuts



ΥΠ. ΑΝΑΠ. ΔΠΠ282/2015



Code	Model	Weighing capacity	Dimensions W*D*Hmm	Price
700.0575	G325	6/15kg sub. 2/5gr	320*380*356 <i>with pole</i>	390 €
700.0576	G325 Electricity	15/30kg sub. 5/10gr	320*380*116 <i>without pole</i>	400 €
700.0578	G325 Power/Battery	15/30kg sub. 5/10gr	320*380*116 <i>without pole</i>	420 €



Electronic scales with calculation Price

PC-5 Battery- Electricity

Description

The PC5 is a durable price-calculating scale with 3 LCD screens and backlighting. It features multiple functions, 10 memory slots, and displays such as weight, unit price, and total price. It comes with a rechargeable battery. Both scales accept standard voltage.



Ideal for outdoor markets and mini-markets

Ministry of Development
Φ2-2721/2013

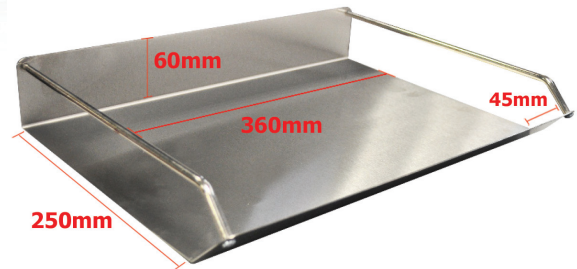

Features

Display	LCD Display
Keyboard	10 visible memory slots
Weighing Capability	15/30 kg, 5/10 g
Power supply	DC: Rechargeable battery 4 Ah/6 V. AC: 230 V/50 Hz. Output: 12 V/1 A
Battery	Battery life: 320 hours without backlight
Scale connections	RS-232 Interface
Dimension tray	360x250mm
Dimensions	Without pole: 320mm x 340mm x 120mm (WxDxH) With pole: 320mm x 340mm x 400mm (WxDxH)



Code	Model	Color of scale	Price
	PC5 30Kg RS232	Sea-blue	300€
700.0261	PC5 30Kg With pole RS232	Sea-blue	340€
700.0265	PC5 30Kg RS232	Black	300€
700.0266	PC5 30Kg With pole RS232	Black	340€
700.0269	Power supply		24€

Code	Dimension tray	Price
700.0610	360x250 with holes	28€
700.0611	360x250 with holes	28€
700.0573	Rail inox	9€

Electronic scales

WX

Description

- Digital Scale with Rechargeable Battery.
- Ideal for indoor and outdoor use.
- Illuminated LCD display (large digits) with backlight.
- Sturdy construction.

 *Ideal for packaging and standardization*

Features

Display	Backlit LCD (large digits)
Power supply	Rechargeable battery
Dimension tray	310 x 220 mm
Dimensions	320 x 330 x 100 mm

Code	Model	Weighing capacity	Price
700.0340	WX	30kg sub. 1gr	240 €
700.0269	Power supply		24 €



Ministry of Development
Φ2-2721/2013



W2

Description

The W2 incorporates a high-precision A/D chip and a load cell. It offers piece counting and speed adjustment functions.

- LED display with red digits
- 4-button keyboard
- Rechargeable battery
- Stainless steel tray / 250 x 180 mm
(Accommodates larger trays)

 *Ideal for packaging and standardization*

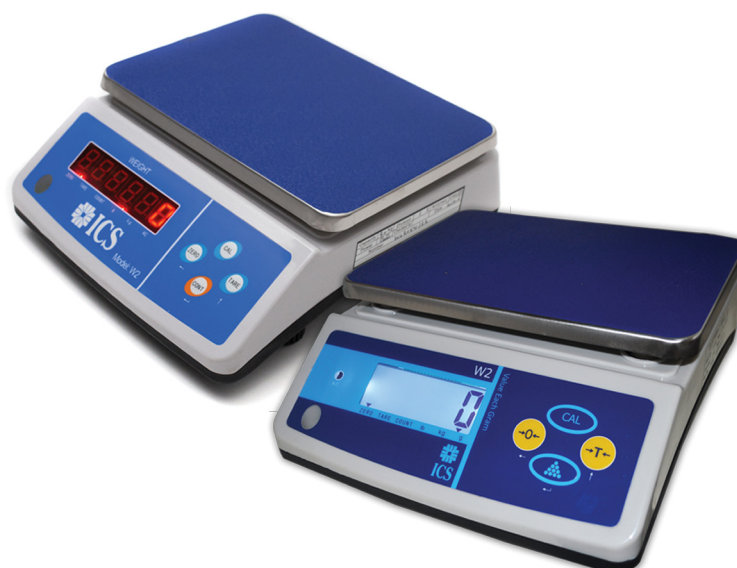

W2C (LCD)

Code	Model	Weighing capacity	Dimensions W*D*Hmm	Price
700.0300	W2	6 kg sub. 0,2gr	280*250*100	120 €
700.0301	W2	15kg sub. 0,5gr	280*250*100	120 €
700.0302	W2	30kg sub. 1gr	280*250*100	120 €
700.0303	W2C (LCD)	30kg sub. 1gr	280*250*100	120 €
700.0304		W2 power supply cable		7 €



Electronic scales

SUPER

Description

- Stainless steel construction with a transparent dust cover
- Stainless steel scale pan
- Waterproof AC/DC power adapter
- Multiple unit conversion: kg, lb, g, oz, pcs.
- Battery level indicator

Ideal for processing foods such as meat, fish, vegetables, fruit, etc. Also suitable for chemical laboratories.



Display	6 digit 0.8" LED
Dimension τάσι	230x190mm
Dimensions ζυγού	400 x 290 x 125mm
Keyboard	4 keys (On, Off (Zero), Tare, Set)
Operating temperature	5°C έως 35°C
Power supply	6V4Ah rechargeable Battery

	Model	Weighing capacity	Price
	700.0310	SUPER 15Kg sub. 1g	300 €
	700.0311	SUPER 30Kg sub. 2g	300 €

RF-100 *Portable digital scale for Freon*

Features

Advanced portable scale for refrigerants. Comes with a special heavy-duty carrying case and a 7-digit backlit LCD display. Non-slip rubber platform. Multiple unit conversion: kg/g/lb/oz. Optional electromagnetic valve - RFW100A. Alarm function.

Ideal for recovering and weighing refrigerant gases.

Code	700.0521
Display	LCD 7 digit
Weighing Capability	100Kg/ Subdivision 5g
Dimensions	335 x 315mm
Weight	2.5kg
Operating temperature	10°C - 50°C
Power supply	Batteries 5 x AA
Price	260 €



S29-MR Battery - Electricity

Heavy-duty stainless steel waterproof scale

Description

- Heavy-duty stainless steel construction
- IP67 waterproof
- Selectable weighing units (kg, oz, lb)
- OIML approval (DK0199.255)
- Seventy (70 hours) of continuous operation without backlight
- Auto off
- Suitable for use in humid environments

Ideal for butcher shops, packaging facilities, cheese factories, bakeries, pastry shops, restaurants, and grill houses.



A.Π. ΔΠ 433/2021

Features

Display	Backlit LCD with large 25mm digits
Dimension tray	230x190mm
Dimensions	W: 243 x D: 299.7 x H: 126.7mm
Keyboard	3-button switch (ON/OFF, ZERO, TARE)
Operating temperature	-10°C to +40°C
Power supply	12V 500mA and rechargeable battery
Weight	4.2 kg



Dimension

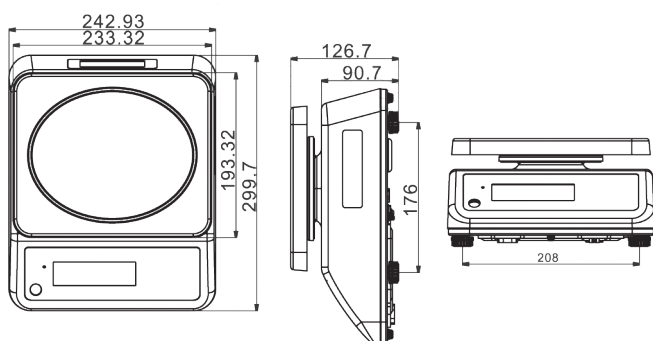

S29-15K-MR-D
S29-15K-MR-D
2 screens



Code	Model	Weighing capacity	Price
700.0000	S29 15kg Stainless Steel, waterproof	6/15Kg sub. 2gr/5gr	300€
700.0001	S29 25kg Stainless Steel, waterproof	15/25Kg sub. 5gr/10gr	300€
700.0030	S29 6kg Stainless Steel, waterproof	3/6Kg sub. 1gr/2gr	300€
700.0031	S29 15kg, 2 screens, Stainless Steel, waterproof	6/15Kg sub. 2gr/5gr	330€
700.0032	S29 25kg, 2 screens, Stainless Steel, waterproof	15/25Kg sub. 5gr/10gr	330€



Scales

NSW Battery - Electricity

Description

- Entirely made of stainless steel
- Scale with indoor/outdoor display
- Tilting display for easy reading
- RS-232 interface for connection to a computer and printer
- OIML approval (DK0199.165)
- Seventy (70) hours of continuous operation without backlight
- IP65 waterproof

 *Ideal for cheese-making, butcher shops*



Features

Display	Backlit LCD with large 52mm digits
Keyboard	7-button switch
Operating temperature	-10°C to +40°C
Power supply	12V 500mA with rechargeable battery



Connectivity options

Code	Model	Weighing capacity	Dimensions mm	Price
700.0012	NSW-60K-MR	30Kg /60Kg sub. 10g/20g	300x400	850 €
700.0006	NSW-150K-MR	60Kg /150Kg sub. 20g/50g	400x500	1080 €
700.0007	NSW-300K-MR	150Kg /300 sub. 50g /100g	600x600	1500 €

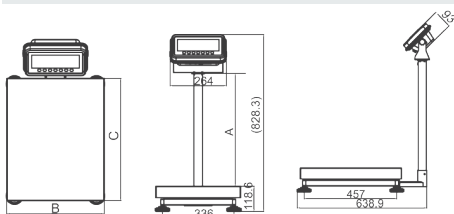

NSW-4050, NSW-6060

	NSW-4050	NSW-6060
A	400	400
B	400	600
C	500	600



Scales

NTW Battery - Electricity

Description

- Scale with indoor/outdoor indicator
- Tilting display for easy reading
- RS-232 interface for connection to a computer and printer
- OIML approval (DK0199.165)
- Seventy (70 hours) of continuous operation without backlight

 *Ideal for receiving areas, warehouses, small workshops, packaging facilities, butcher shops, and supermarkets.*



Features

Display	Backlit LCD with large 52mm digits
Keyboard	7-button switch
Operating temperature	-10°C to +40°C
Power supply	12V 500mA with rechargeable battery



Code	Model	Weighing capacity	Dimensions mm	Price
700.0002	NTW-30K-MR	15Kg/30Kg sub. 5g/10g	300x240	440 €
700.0003	NTW-150K-MR	60Kg/150Kg sub. 20g/50g	400x400	560 €
700.0004	NTW-300K-MR	150Kg/300Kg sub. 50g/100g	600x600	880 €
700.0005	NTW-600K-MR	300Kg/600Kg sub. 100g/200g	800x800	1000 €



Scales

X2-C Battery - Electricity

Description

- LCD display with digits and indoor/outdoor backlight
- Stainless steel base and stand
- Heavy-duty construction
- Runs on a rechargeable battery
- Low battery indicator
- RS-232
- Tilting head for easy reading

Ideal for warehouses, receiving areas, and small-scale manufacturing facilities

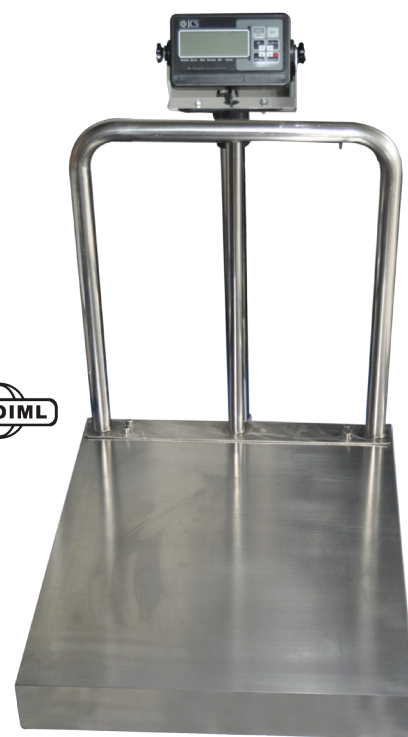

Code	Model	Weighing capacity	Dimensions W*D*Hmm	Price
700.0352	X2-C	150Kg sub.	500*600	700 €
700.0356	X2-C	600Kg sub. 100gr	600*800	700 €
700.0357	X2-C	600Kg sub. 100gr	800*800	770 €
700.0366	HI Adaptor	-	-	16 €

BSP with a plastic base and a K1 head

Description

- Scale with rechargeable battery
- Backlit LED display with red digits
- Tilting display for easy reading
- Operates smoothly from -15°F to 40°F
- Waterproof keyboard

Ideal for packaging facilities, warehouses, and supermarkets



Code	Model	Weighing capacity	Dimensions W*D*Hmm	Price
700.0361	BSP	100kg sub. 20gr	300*400	550 €
700.0362	BSP	200kg sub. 50gr	400*500	580 €
700.0364	HI Adaptor for Indicative X9			25 €

Scales

ATC/ATK *Battery - Electricity*

Description

- **ATC4:** LCD display with digits and backlight for indoor/outdoor use
- **ATK:** LED display with digits for indoor use
- Operates on a rechargeable battery
- Stainless steel housing
- RS-232
- Painted railing
- Tilting head for easy reading

Ideal for warehouses, receiving areas, and small-scale manufacturing facilities



Weight indicator X2



Weight indicator X0

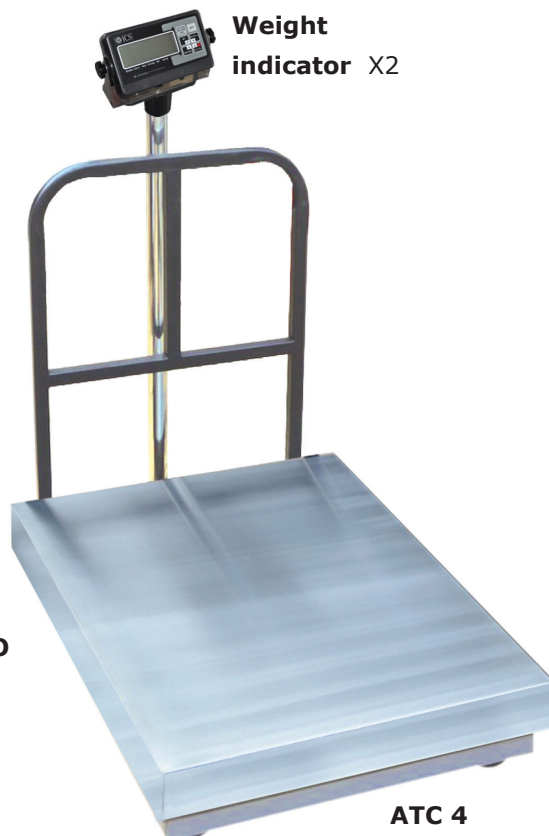

Weight indicator X2

ATC 4

ATK



Code	Model	Weighing capacity	Dimensions mm	Price
700.0350	ATC4 with X2 head	200Kg sub. 20gr	400*500	290 €
700.0360	ATK with X0 head	300Kg sub. 50gr	500*600	380 €
700.0366	HI ADAPTOR X2	-	-	16 €
700.0367	HI ADAPTOR ATK 8V	-	-	15 €
700.0368	HI ADAPTOR ATK 12V	-	-	25 €



Floor-Mounted Receiving Scales

FD Painted with a head X3

- 4 aluminum load cells
- Compatible with any weight indicator
- Compatible with long Painted Ramper



Code	Model	Weighing capacity	Dimensions	Price
700.0400	FD	3000Kg/1Kg	100*100*11	1.400 €
700.0401	FD	3000Kg/1Kg	120*120*11	1.500 €
700.0402	FD	3000Kg/1Kg	150*150*11	1.600 €
	Ramper		1.00*0.60	
	Ramper		1.20*0.80	
	Ramper		1.50*0,60	

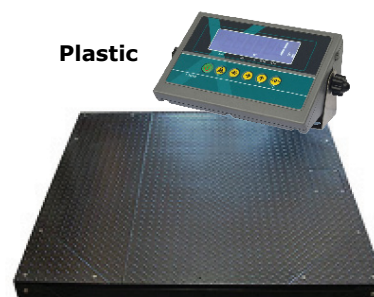

Plastic



FDS Inox with a head X3

- 4 stainless steel load cells (IP 67)
- Stainless steel junction box (IP 64)

Code	Model	Weighing capacity	Dimensions	Price
700.0405	FDS Inox	3000Kg/1Kg	100*100*11	2.700 €
700.0406	FDS Inox	3000Kg/1Kg	120*120*11	2.800 €
	FDS Inox	3000Kg/1Kg	150*150*11	
	Ramper		1.00*0.60	
	Ramper		1.20*0.60	
	Ramper		1.50*0,60	



Inox



FDLS Inox / FDL Painted with a head X3

- Stainless steel: 4 stainless steel load cells with IP 67 rating
- Painted: 4 aluminum load cells
- Compatible with any weight indicator
- Features a low loading height
- Comes with two ramps
- Equipped with carrying handles



Code	Model	Weighing capacity	Internal dimensions	External dimensions	Price
700.0410	Fdl Painted	3000Kg/1Kg	120*120*50	120*140*50	2400 €
700.0416	Fdls Inox	3000Kg/1Kg	120*120*50	120*140*50	4600 €
700.0411	Fdl Painted	3000Kg/1Kg	150*150*50	150*170*50	3000 €
700.0417	Fdls Inox	3000Kg/1Kg	150*150*50	150*170*50	5000 €
700.0415	Fdls Inox	1500kg/500gr	0,80*0,80*50	0,80*1,00*50	3200 €

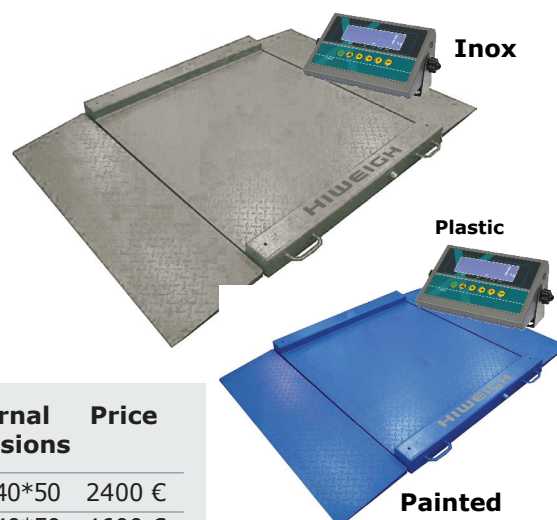

Inox

Plastic

Painted



PHA *pallet truck*

Description

Code 700.0430

- Designed for industrial use
- 2,000 kg/1 kg
- 1.2" backlit LED display, 6 digits, 24 mm
- Weighing with 4 load cells
- Rechargeable battery
- Battery life: 60 hours of continuous operation
- Waterproof keyboard
- 2 RS232 outputs
- Fork length: 1,135 mm
- Fork width: 180 mm



Ideal for receiving, weighing, and transporting

PRICE 1600 €



MP *engineer*

Description

- Mechanical Scale
- Heavy-duty



Ideal for outdoor deliveries and pickups in areas without electricity



Code	Model	Weighing capacity	Dimensions	Price
700.0435	MP-660	500kg sub. 200gr	600*600	500 €
700.0436	MP-680	1000kg sub. 200gr	600*800	580 €

Hanging scales - Hanging scales

CSE



- Automatic shutdown when not in use
- Low battery consumption mode
- Aluminum coating
- 5-digit indoor LED display
- Operates with rechargeable battery



Ideal for industrial aluminum, iron, and recycling facilities

Code	Model	Weighing capacity	Dimensions W*D*H	Price
700.0450	CSE	300	222*128*370 mm	
700.0451	CSE	500kg sub.100gr	222*128*370 mm	380
700.0452	CSE	1000kg sub.500gr	222*128*370 mm	450
700.0901	HI ANT/KO BATTERY CSE 6V5AH/INS-100			30

CSB-T



- 5-digit indoor LED display
- Low battery indicator
- Automatic shutdown
- Power-saving function
- 12 kg
- Operates with rechargeable battery



Ideal for industrial aluminum, iron, and recycling facilities

Code	Model	Weighing capacity	Dimensions W*D*H	Price
700.0455	CSB-T	sub.1000gr	800*300*420 mm	90
	CSB-T	10T sub. 5000gr	800*300*420 mm	1300

CX & CXX Lightweight buckets

Description

- Indoor/outdoor LCD backlight display
- Low battery indicator
- Aluminum construction
- **CX**: Operates with 2 AA batteries
- **CXX**: Operates with 3 AA batteries
- **CR**: Operates with 2 AAA batteries



Ideal for industrial aluminum, iron, and recycling facilities, as well as lighter courier applications

Code	Model	Weighing capacity	Price
700.0460	CX 120	120kg sub. 50gr	160
700.0461	CX 300	300kg sub. 100gr	180
700.0465	CXX 300	300kg sub. 100gr	280
700.0466	CXX 500	500kg sub. 200gr	300
700.0467	CXX 1000	1000kg sub. 500gr	300
700.0470	CR	50kg sub. 20gr	40



Weight indicators

X-3M Inox

Electronic

LCD backlight display **Waterproof**
keyboard Entirely stainless steel
 RS-232 output Rechargeable
 battery



Code: 700.0701

Price: €300 with wall mount

X2

Electronic

LCD backlight display **Waterproof**
keyboard Rechargeable battery
 RS-232 output
 Dimensions 190*55*108



Code: 700.0700

Price: €125 with wall mount

RWS *Electronic*

LCD backlight display
Waterproof
Entirely stainless steel RS-232
 output Rechargeable battery



Code: 700.0019 Price:
€440

NTW *Electronic*

LCD backlight display **ABS**
plastic Rechargeable battery RS-
 232 output
 Dimensions 250*162*133



Code
Price



DFWT *Digital*

Code: 700.0702

Digital weight indicator with attached thermal
 printer, suitable for any industrial or commercial
 use.

Available in two versions: with LED or LCD
 illuminated display

Waterproof 17-key keyboard Waterproof IP65-
rated enclosure

Dimensions: 278*12*186mm Built-in clock &
 rechargeable battery

Two RS232 serial ports

Price: €1,100



NSW *Electronic*

LCD backlight display **Stainless**
steel Rechargeable battery RS-
 232 output
 Dimensions 190*55*108



Rail scale *with head* *selection*

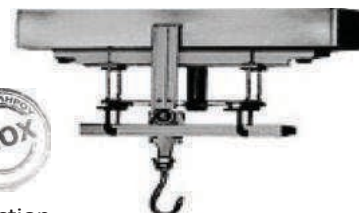

- Heavy-duty construction
- Weighing on a stainless steel or OP load cell
- Adapts to any type of conveyor (Helm, blade or tube, etc.)
- Ideal for weighing meat

Code	Length	Weighing capacity	Price
700.0500	40 cm	300 kg sub. 100 g	1300
700.0501	40 cm	600 kg sub. 200 g	1400

Electronic scales

MD series of pocket scales

Features

Stainless steel scale, high precision, ideal tool for precious and semi-precious stones

- 5 1/2-digit LCD display
- Multiple weighing units (g, oz, gn, ct)
- Power supply: 2 AAA batteries
- Dimensions: 71.1x122x20.3mm/Stainless steel weighing pan 63.5x76mm



Code	Model	Weighing capacity	Price
700.0530	MD	200g sub. 0,01gr	45 €
700.0531	MD	300g sub. 0,01gr	45 €
700.0532	MD	500g sub. 0,1gr	45 €
700.0533	MD	1000g sub. 0,1gr	45 €

CSF piece counting

Features

Display Backlit LCD display with three readouts:

1. Weight/count
2. Total weight
3. Total count

Memories 8 digits

Battery Rechargeable



Code	Model	Weighing capacity	Dimensions	Price
700.0510	CSF	15kg sub. 0,5gr	310*255mm	200 €



Ideal for paint stores and costume jewelry shops

CCX piece counting

Features

Display Backlit LCD display with three readouts:

1. Weight/count
2. Total weight
3. Total count

Memories 8 digits

Battery Rechargeable



Code	Model	Weighing capacity	Dimensions	Price
700.0511	CCX	30kg sub. 1gr	310*255mm	210 €



Ideal for paint stores and costume jewelry shops

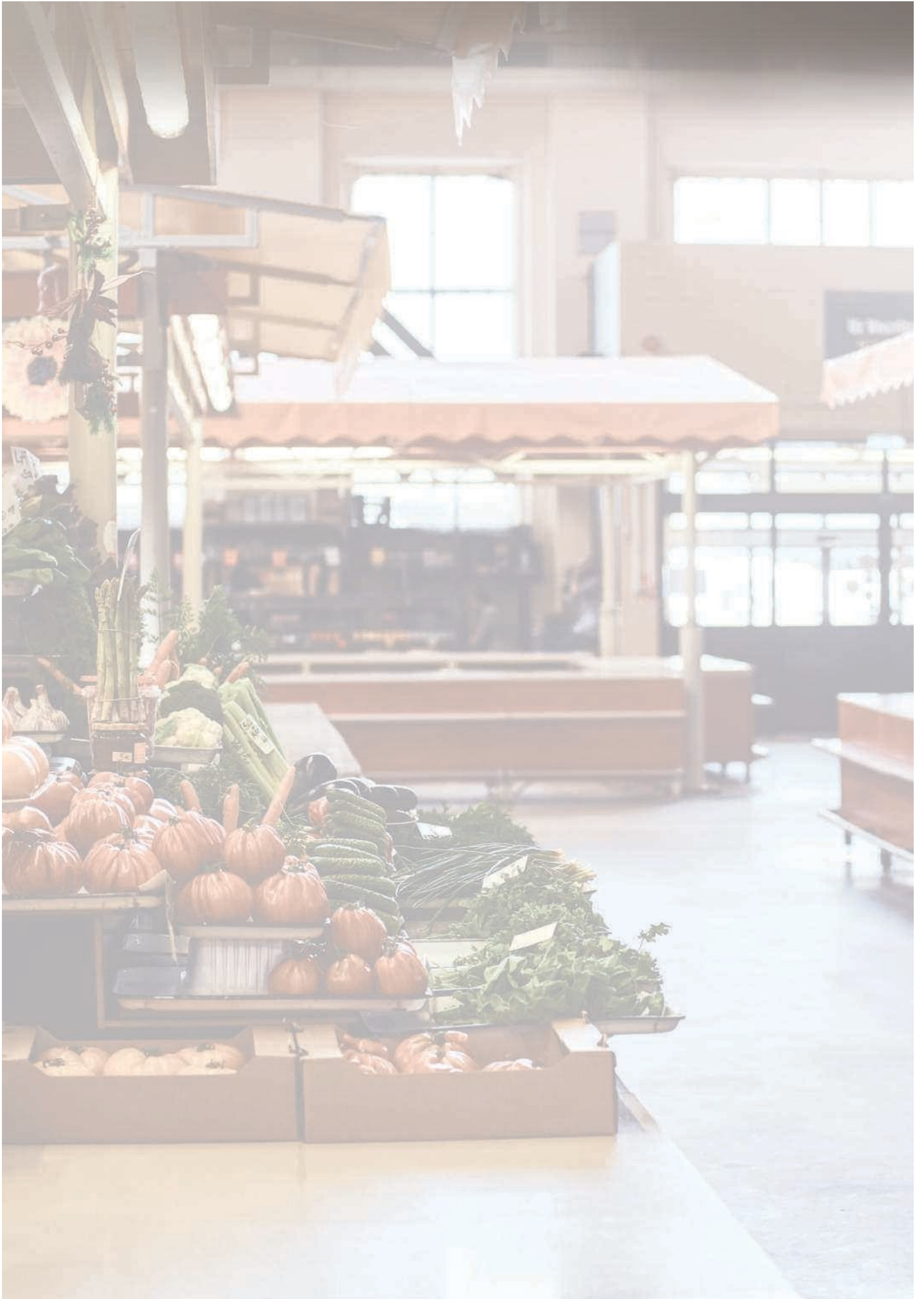

3030211

€ 1,6264

KÄSEP PROFFICE 8/32 KOKKINO



3030211

€ 1,6264

KÄSEP PROFFICE 8/32 KOKKINO

Label Printers
Labels
Consumables

Taggers

Jolly

The Jolly label printer can also be used to print dates on products. The ink roll is easy to replace. Extremely durable construction made of special plastic; easy to use and lightweight. Protective cover and easy label replacement. High speed, fast results, variety of label sizes. Spare parts available.

 *Ideal for clothing stores, cosmetics stores, pharmacies, butcher shops, bakeries, grocery stores, cafés, electronics stores, musical instrument stores, toy stores, electronics stores, flower shops, pet supply stores, furniture stores, bookstores, and any retail store.*



	Code	Color	Series	Digit	Dimensions	Consumables	Price
JC8 2612	085.9507	red	1	8	26x12mm	Ink Roller	31,50€
JC8 2612	085.9508	Black	1	8	26x12mm	Ink Roller	31,50€
JH8 2112	085.9509	red	1	6	21x12mm	Ink Roller	33,00€
JH8 2112	085.9510	Black	1	8	21x12mm	Ink Roller	33,00€
JS16 2616	085.9511	Black	2	8+8	26x16mm	Ink Roller	50,00€
JS16 2616	085.9512	red	2	8+8	26x16mm	Ink Roller	50,00€

Jolly

Label applicator featuring Jolly's Italian craftsmanship. Comes with a standard needle.

 *Ideal for use on clothing, footwear, fabrics, etc.*

085.9536	Jolly's	1	15,00€
085.9538	Plastic pins	10.000τμχ 25mm	12,00€
085.9539	Plastic pins	10.000τμχ 50mm	12,00€
085.9537	Metal needles	5pieces set	11,00€



Labels for label makers

	Code	Price
Speedy-Motex	085.9530	3,00€
Jolly	085.9531	3,00€
Swing	085.9532	3,00€
Open	085.9533	3,00€
Blitz	085.9534	3,00€
Open triple	085.9535	5,50€

Prices do not include VAT. Prices are subject to change without notice. The company is not responsible for any typographical errors.

Taggers

Speedy

The Speedy label printer is a manual device used for labeling products with the production date, weight, price, product code, and any other digital information. The labels are self-adhesive on one side and are loaded into the machine in roll form. It is very easy to use with simple replacement of consumables. Precise printing of information on the label, vertical adjustment capability, and multiple information symbols for the label.



Perfect for any retail store.



	Code	Color	Series	Digit	Dimensions	Consumables	Price
DBH8 2112	085.9500	Black	1	8	21x12mm	Ink Roller	27,00€
DBH8 2112	085.9501	red	1	8	21x12mm	Ink Roller	27,00€
DBC6 2612	085.9506	blue	1	6	26x12mm	Ink Roller	31,50€
DBC8 2612	085.9502	Black	1	8	26x12mm	Ink Roller	27,00€
DBC8 2612	085.9503	red	1	8	26x12mm	Ink Roller	27,00€
DBS16 2616	085.9504	Black	2	8+8	26x16mm	Ink Roller	47,00€
DBS16 2616	085.9505	red	2	8+8	26x16mm	Ink Roller	47,00€

Blitz

A device for printing prices on product labels. This label printer is commonly used for products such as food, fruit, vegetables, jewelry, equipment, tobacco products, and more.



Ideal for bakeries, butcher shops, coffee shops, cheese shops, clothing stores, jewelry stores, pastry shops, fish markets, flower shops, shoe stores, fruit and vegetable shops, restaurants, liquor stores, herbal and organic product shops, gelaterias, perfume shops, pharmacies, pizzerias, tobacco shops, stationery stores, supermarkets, etc.



	Code	Color	Series	Digit	Dimensions	Consumables	Price
C8 2612	085.9524	Black	1	8	26x12mm	Ink Roller	54,00€
S16 2616	085.9525	Black	2	8+8	26x16mm	Ink Roller	92,00€
C6 2612	085.9526	Black	1	6	26x12mm	Ink Roller	54,00€
C10 2612	085.9527	Black	1	10	26x12mm	Ink Roller	72,00€
C20 2616	085.9528	Black	2	10+10	26x16mm	Ink Roller	98,00€
T107 2928	085.9529	Black	3	11+space+7	29x28mm	Ink Roller	145,00€



Taggers

Open

A label printer used for printing prices and dates on products. The ink roll is replaceable. Extremely durable plastic construction, easy-to-use machine, lightweight, with a label roll in a protective cover and easy to load. Labels can be changed in a matter of seconds. High-speed printing, fast label output, full range of options for different label dimensions. High flexibility due to the wide range of applications. Spare parts available.

 Perfect for any retail store.



T117 2928













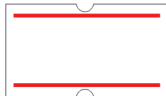

L22 3219

	Code	Color	Series	Digit	Dimensions	Consumables	Price
C8 2612	085.9516	Black	1	8	26x12mm	Ink Roller	54,00€
S16 2616	085.9517	Black	1	8	26x16mm	Ink Roller	92,00€
P6 2212	085.9518	Black	1	6	22x12mm	Ink Roller	55,00€
C20 2616	085.9519	Black	2	10+10	26x16mm	Ink Roller	98,00€
T117 2928	085.9520	Black	3	11+11+7	29x28mm	Ink Roller 1-2 Lines	200,00€
L22 3219	085.9521	Black	2	12+12	32x19mm	Ink Roller 1-2 Lines	165,00€
S14 2616	085.9522	Black	2	8+6	26x16mm	Ink Roller	57,00€



Prices do not include VAT. Prices are subject to change without notice.
The company is not responsible for any typographical errors.

Labels

Product	Label	Price		
Code 085.9541 White label lines Dimensions: 21 x 12 mm Packaging: 1,000 labels per roll 50 rolls per box		0,53 €		
Code 085.9542 White label Dimension 21x12mm Packaging 1000label/roll 50rolls/per box		0,50 €		
Code Label with logo Dimension 21x12mm Packaging 1000label/roll 50rolls/per box	085.9543 	085.9544 	085.9545 	0,63 €
Code Label fluorescent Dimension 21x12mm Packaging 1000label/roll 50rolls/per box	085.9546 	085.9547 	085.9548 	0,75 €
Code 085.9549 White label Dimension 22x12mm Packaging 1000label/roll 50rolls/per box		0,50 €		
Code Label fluorescent Dimension 22x12mm Packaging 1000label/roll 50rolls/per box	085.9551 	085.9550 	0,70 €	
Code 085.9552 White label Dimension 26x12mm Packaging 1000label/roll 40rolls/per box		0,50 €		
Code 085.9553 Label yellow Dimension 26x12mm Packaging 1000label/roll 40rolls/per box		0,68 €		

Product	Label			Price	
Code Dimension 26x12mm Packaging 1000label/roll 40rolls/per box	085.9554 	085.9555 	085.9556 	0,54 €	
Code Label fluorescent Dimension 26x12mm Packaging 1000label/roll 40rolls/per box	085.9558 	085.9559 	085.9557 	0,74€	
Code 085.9560 White label Dimension 26x16mm Packaging 1000label/roll 36rolls/per box				0,84 €	
Code 085.9562 Label yellow Dimension 26x16mm Packaging 1000label/roll 36rolls/per box				0,78 €	
Code Label with logo Dimension 26x16mm Packaging 1000label/roll 36rolls/per box	085.9563 	085.9564 	085.9565 	085.9566 	0,87 €
Code Label fluorescent Dimension 26x16mm Packaging 1000label/roll 36rolls/per box	085.9568 	085.9569 	085.9567 	0,90 €	
Code 085.9561 White label Dimension 26x16mm Packaging 1000label/roll 36rolls/per box				0,90 €	
Code 085.9594 White label Dimension 29x28mm Packaging 700label/roll 30rolls/per box				1,00 €	
Code 085.9570 White label Dimension 32x19mm Packaging 1000label/roll 30rolls/per box				0,90 €	

Labels

Labels for electronic scales & printers

Code	Description	Packaging	Price
085.9573	Thermal labels 30x15	1000 label/rolls - 50rolls/per box	3,20 €
085.9574	Thermal labels 38x45 printed	600 label/rolls - 48rolls/per box	2,50 €
085.9575	Thermal labels 40x20	1000 label/rolls - 45rolls/per box	4,20 €
085.9576	Thermal labels 45x35	1000 label/rolls - 50rolls/per box	5,00 €
085.9577	Thermal labels 48x40 printed	700 label/rolls - 48rolls/per box	3,80 €
085.9578	Thermal labels 55x25	1000 label/rolls - 40rolls/per box	5,00 €
085.9579	Thermal labels 57x40 printed blue	1100 label/rolls - 24rolls/per box	5,00 €
085.9580	Thermal labels 57x40 printed blue	800 label/rolls - 32rolls/per box	4,70 €
085.9581	Thermal labels 57x40 printed blue	700 label/rolls - 30rolls/per box	4,40 €
085.9582	Thermal labels 57x40	700 label/rolls - 32rolls/per box	4,20 €
085.9583	Thermal labels 57x45	700 label/rolls - 30rolls/per box	3,70 €
085.9584	Thermal labels 57x60	650 label/rolls - 30rolls/per box	4,50 €
085.9585	Thermal labels 57x60	450 label/rolls - 30rolls/per box	3,90 €
085.9586	Thermal labels 58x43	800 label/rolls - 30rolls/per box	3,80 €
085.9587	Thermal labels 58x43	700 label/rolls - 30rolls/per box	3,50 €
085.9588	Thermal labels 60x40	700 label/rolls - 30rolls/per box	4,00 €
085.9589	Thermal labels 60x55	700 label/rolls - 30rolls/per box	4,40 €
085.9590	Thermal labels 70x40	1000 label/rolls - 30rolls/per box	6,30 €
085.9591	Thermal labels 80x40	1000 label/rolls - 30rolls/per box	6,95 €
085.9592	Thermal labels 105x75	250 label/rolls - 30rolls/per box	5,80 €
085.9593	Thermal labels 105x150	250 label/rolls - 30rolls/per box	7,50 €

Samples

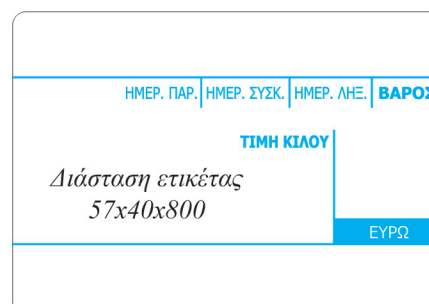
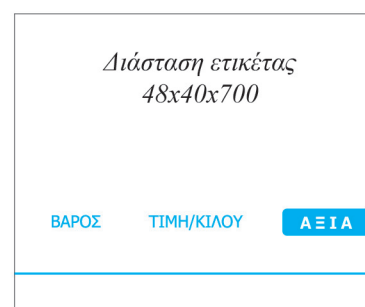
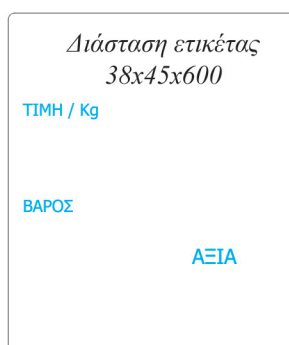
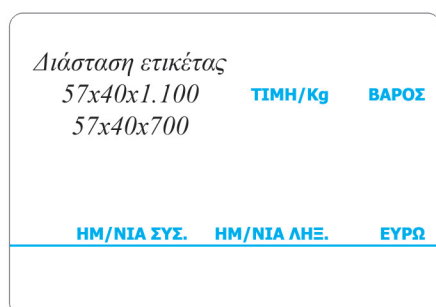

Food Machinery



ICS KARAFYLLIS S.A
IT SYSTEMS & FOOD PROCESSING EQUIPMENT

Head: 36-38 Agia Paraskevi Street, Peristeri, PC 12132
Tel: 210 5778260-3, **Fax:** 210 5754285
Email: sales@ics.gr

Northern Greece Branch: 10 Nikopoleos & Asklipiou, Polichni,
Thessaloniki, PC 56430 - **Tel.:** 2310 614212
Email: salesng@ics.gr

www.ics.gr • www.amersec.gr • www.icsfm.gr



Follow us

